



# OLYMPIA KAI

HOUT – BOIS – WOOD

NL - Installatiehandleiding

FR - Notice d'installation

EN - Installation manual

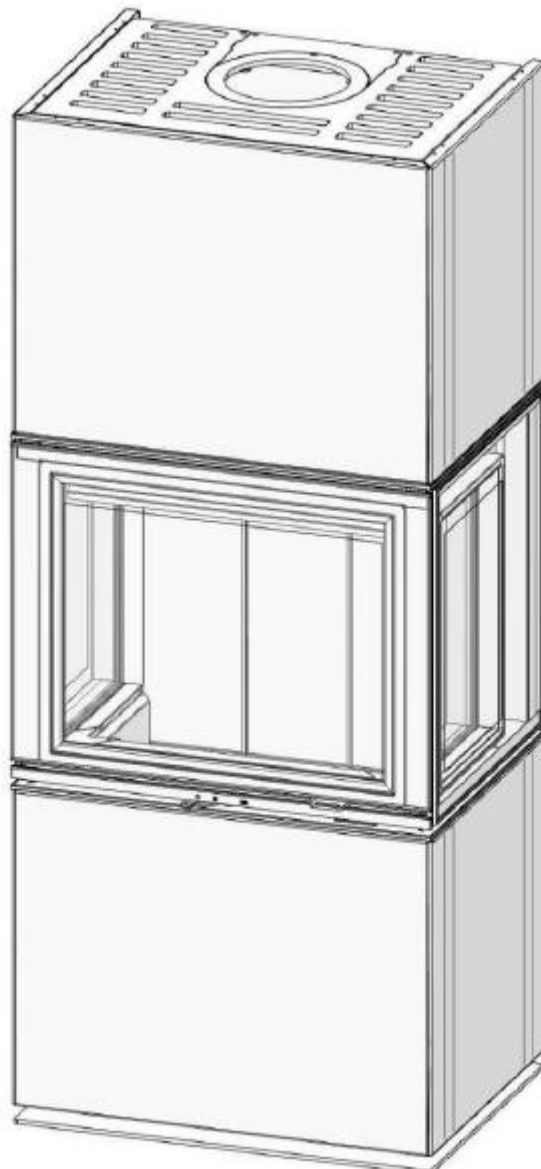

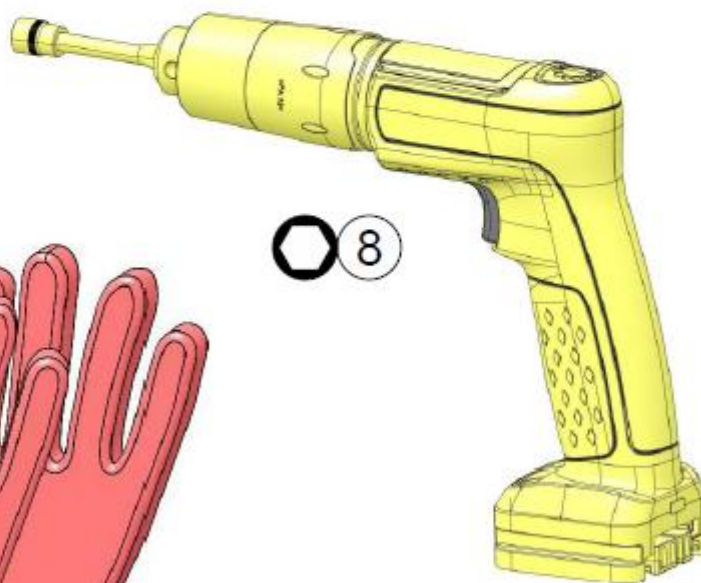
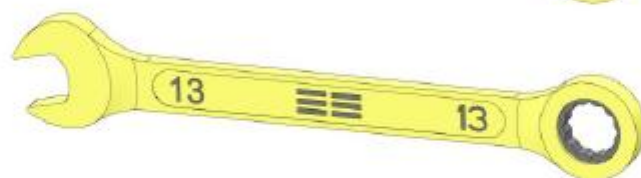
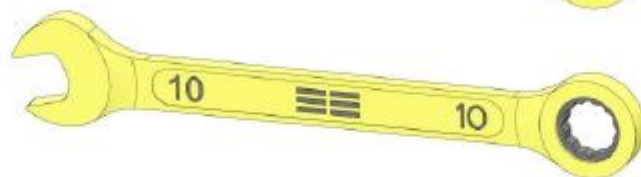
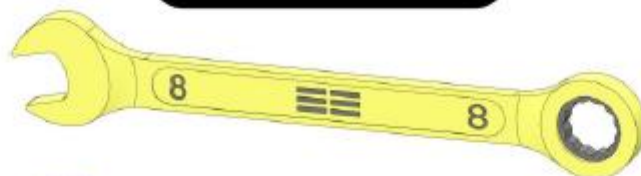

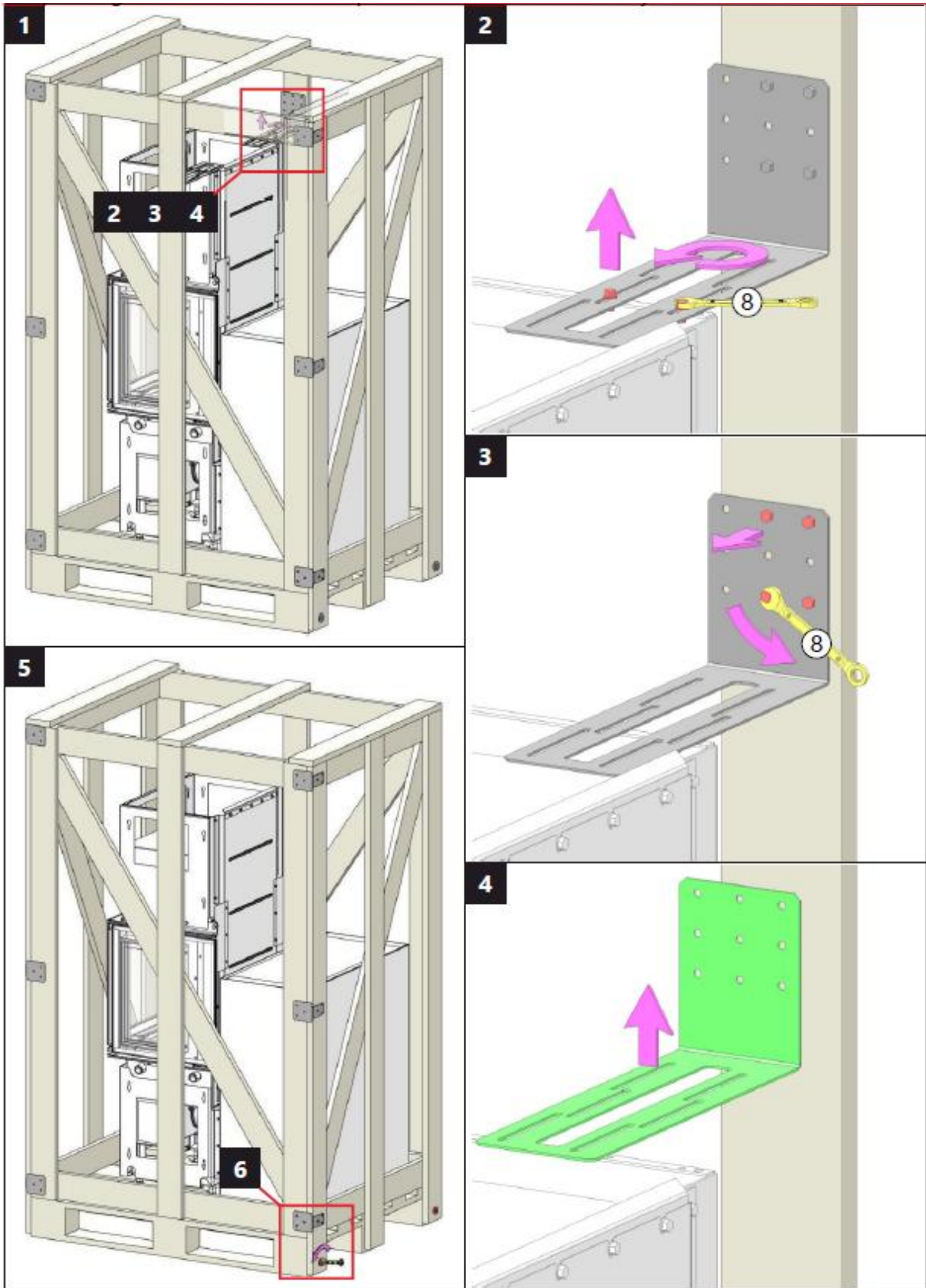

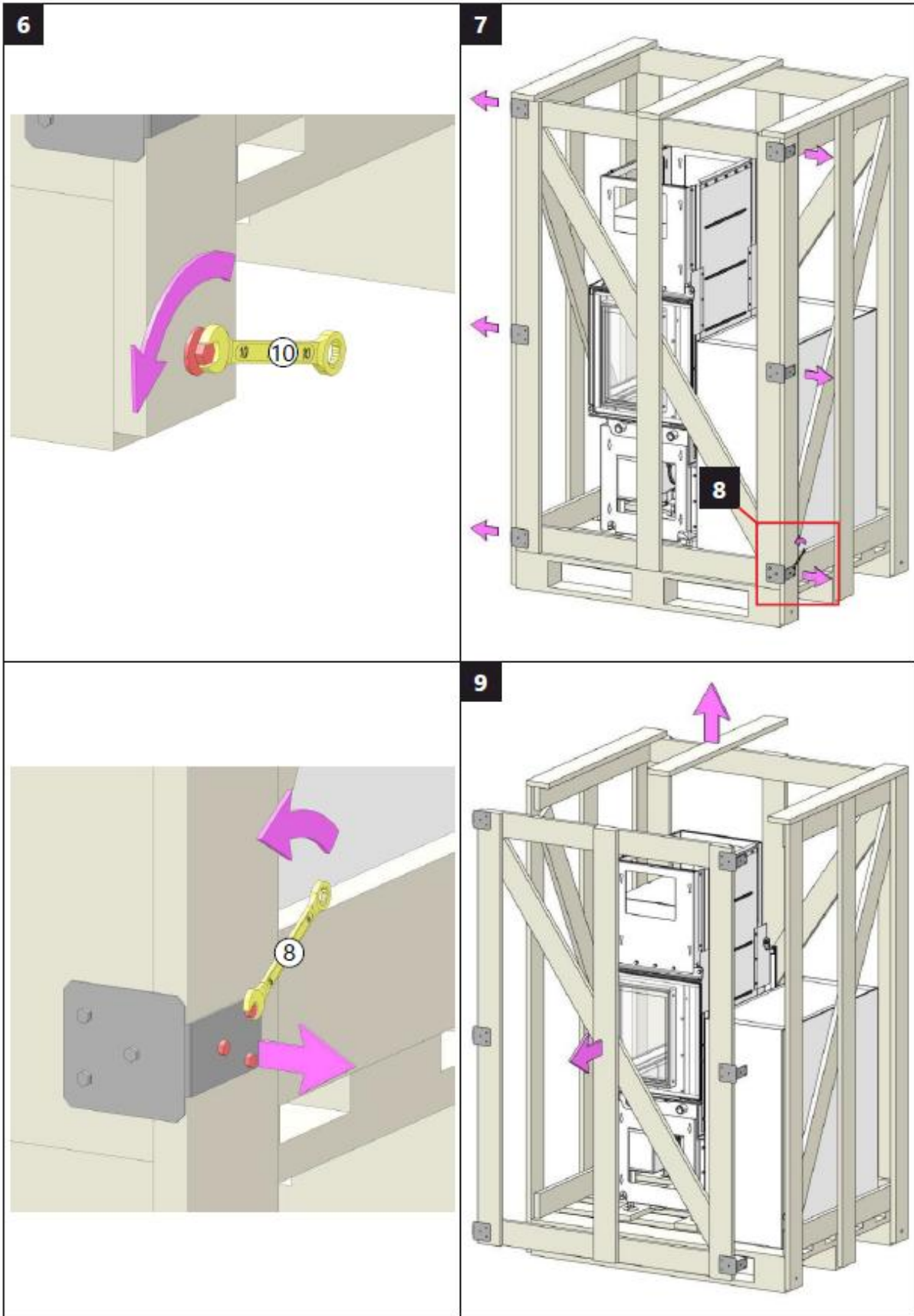

10

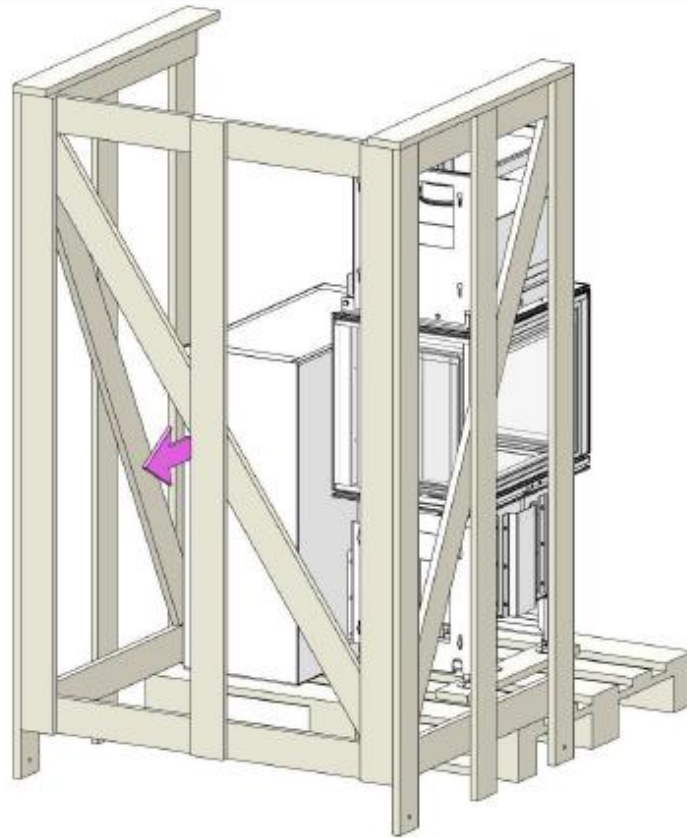

11

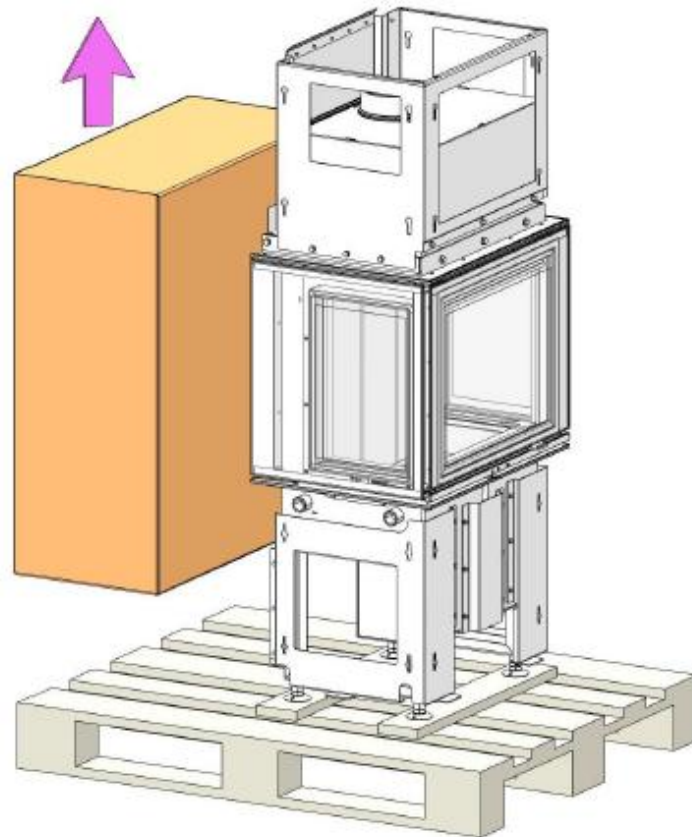

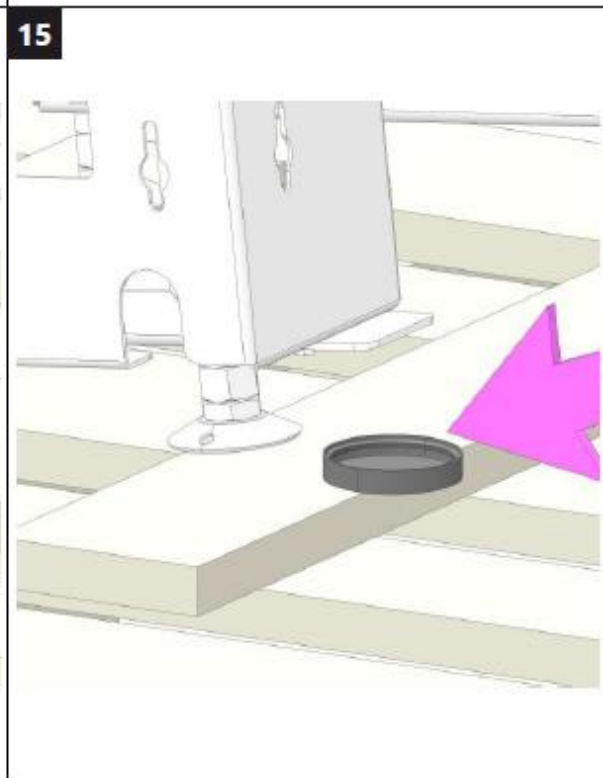
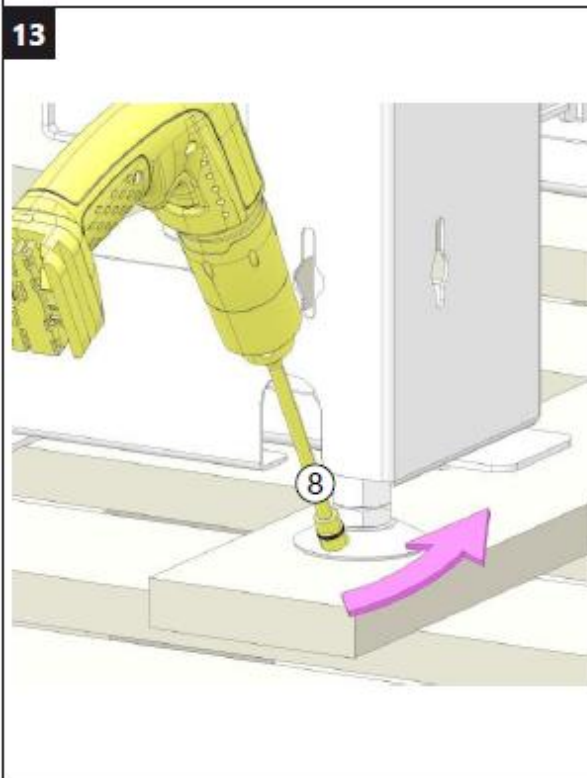
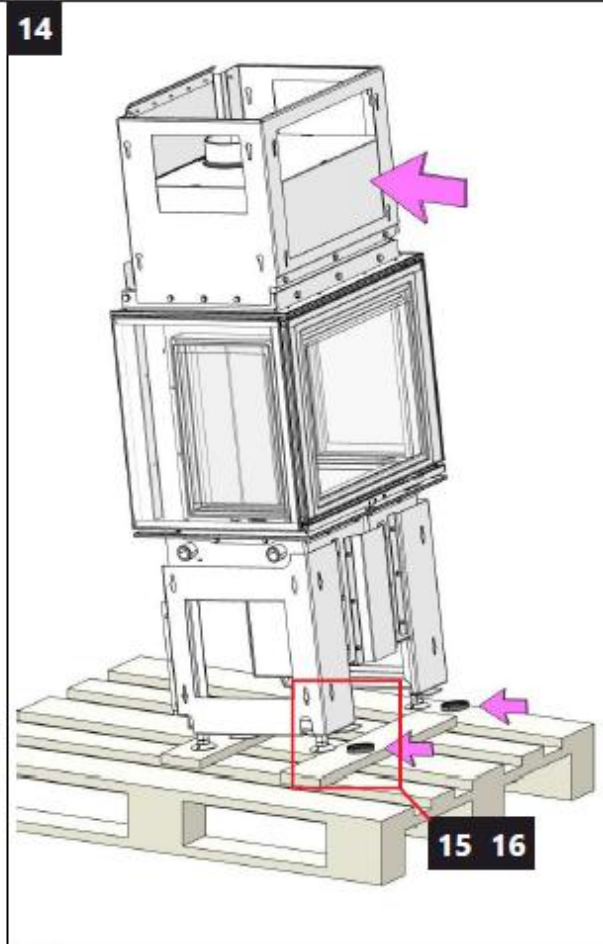
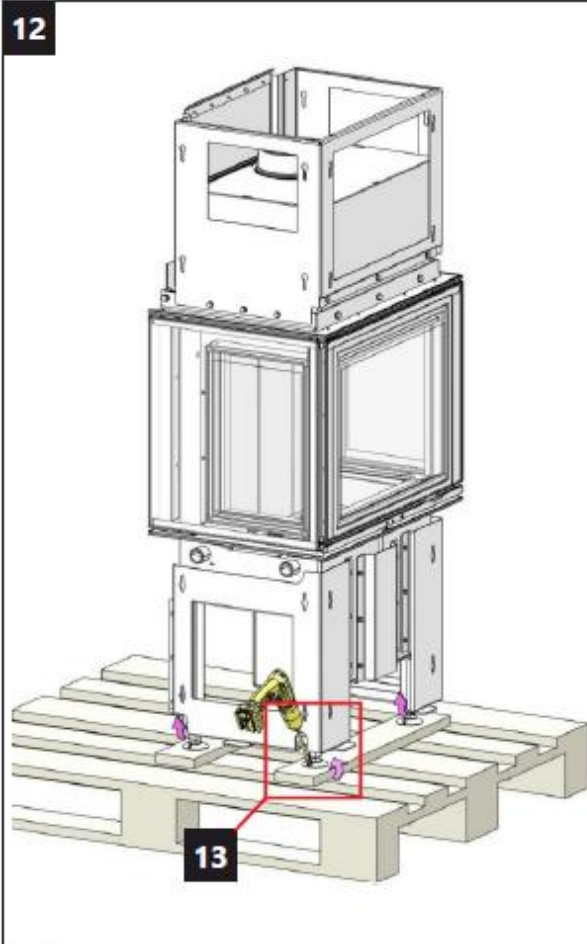

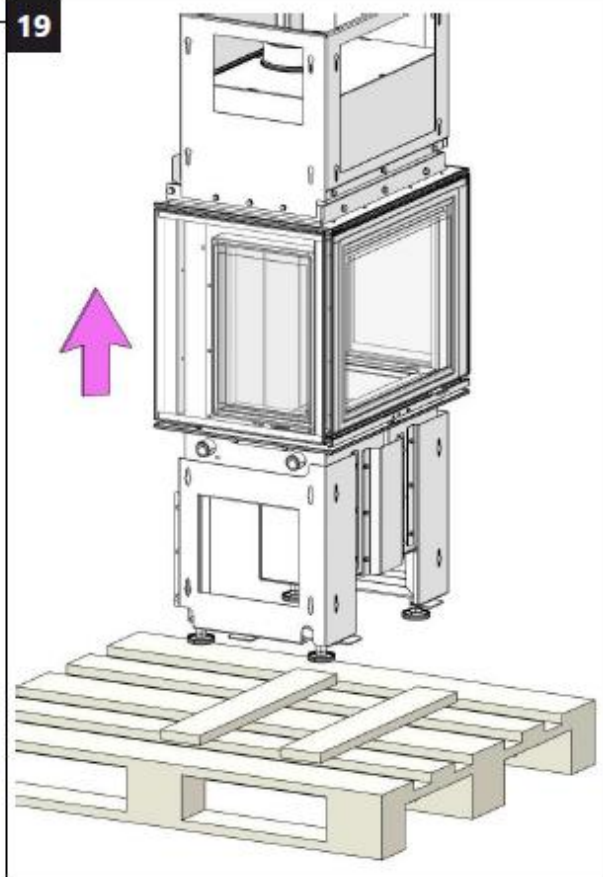
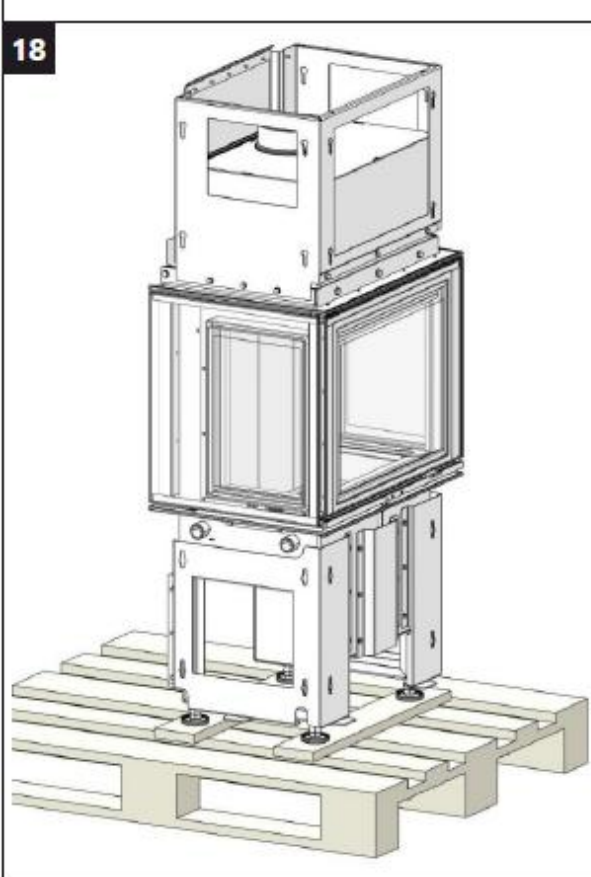
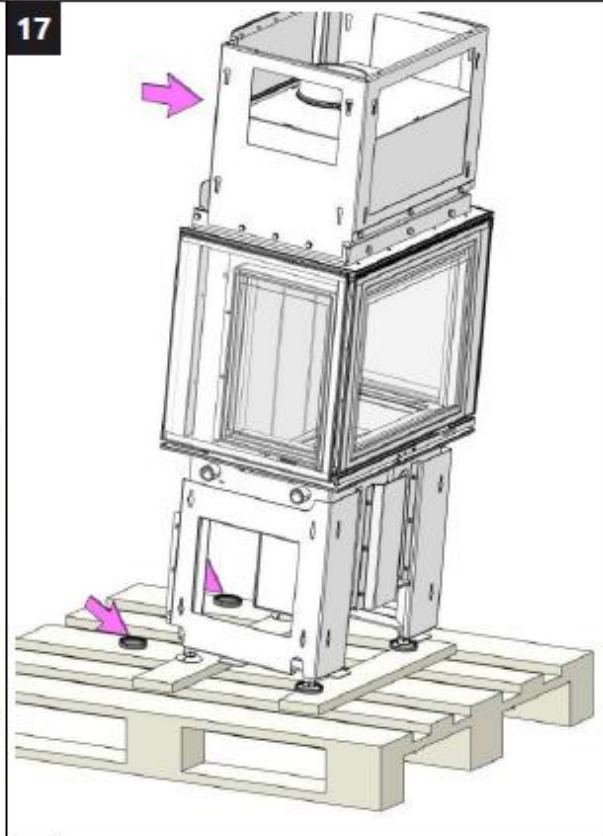
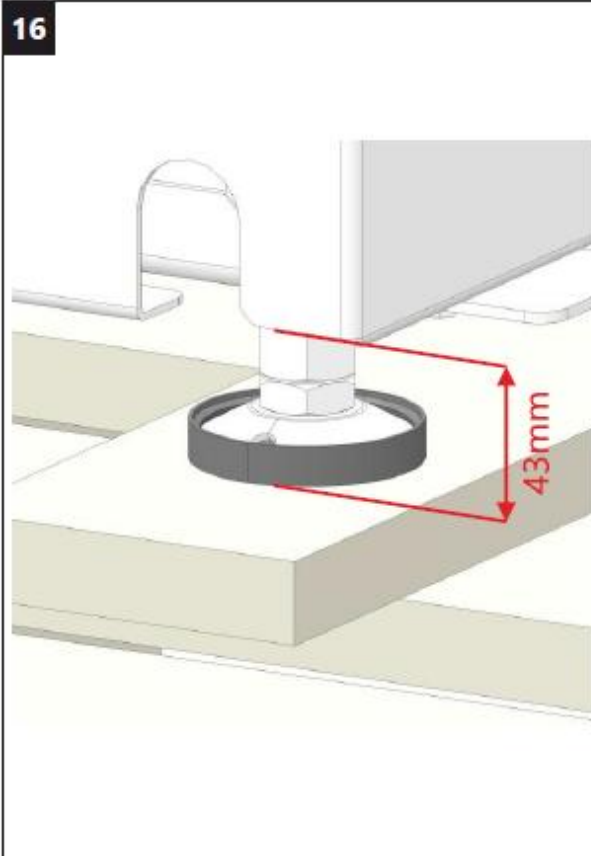





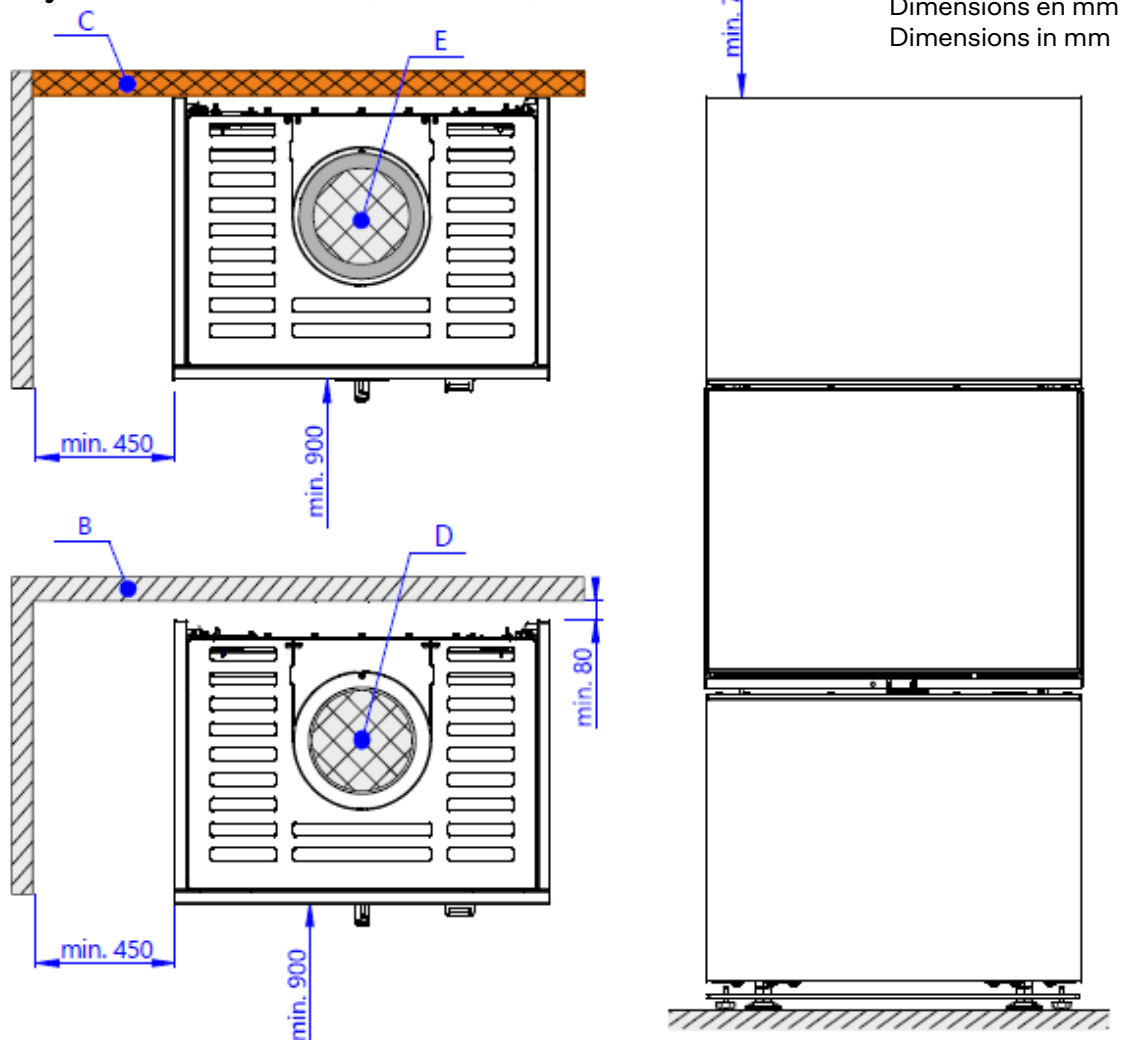

20

**Veiligheidsafstand tot brandbare materialen**  
**Distance de sécurité par rapport aux matériaux inflammables**  
**Safety distance from flammable materials**



A		Brandbaar plafond	Plafond inflammable	Flammable ceiling
B		Brandbare muur	Mur inflammable	Flammable wall
C		Isolatiebescherming (muur)	Protection isolante (mur)	Protective insulation (wall)
D		Rookkanaal zonder isolatie	Conduit de fumée sans isolation	Flue without insulation
E		Rookkanaal met isolatie	Conduit de fumée avec isolation	Flue with insulation









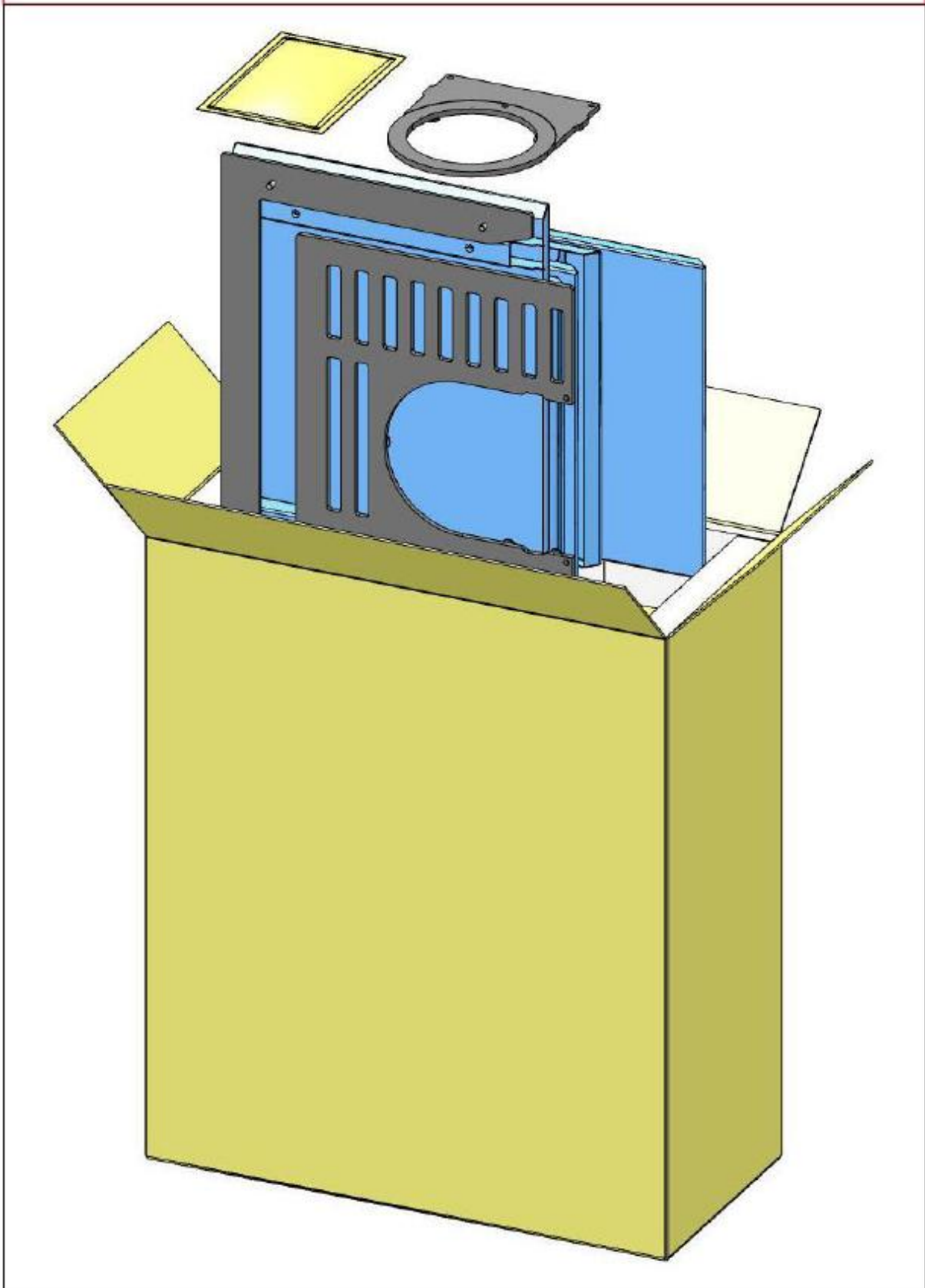

De installatie moet altijd in overleg met een schoorsteenveger plaatsvinden en alle lokale voorschriften moeten worden nageleefd, inclusief voorschriften die betrekking hebben op nationale en Europese normen!

L'installation doit toujours être effectuée en concertation avec un ramoneur et toutes les réglementations locales doivent être respectées, y compris celles relatives aux normes nationales et européennes !

Installation must always be carried out in consultation with a chimney sweep, and all local regulations must be complied with, including those relating to national and European standards!

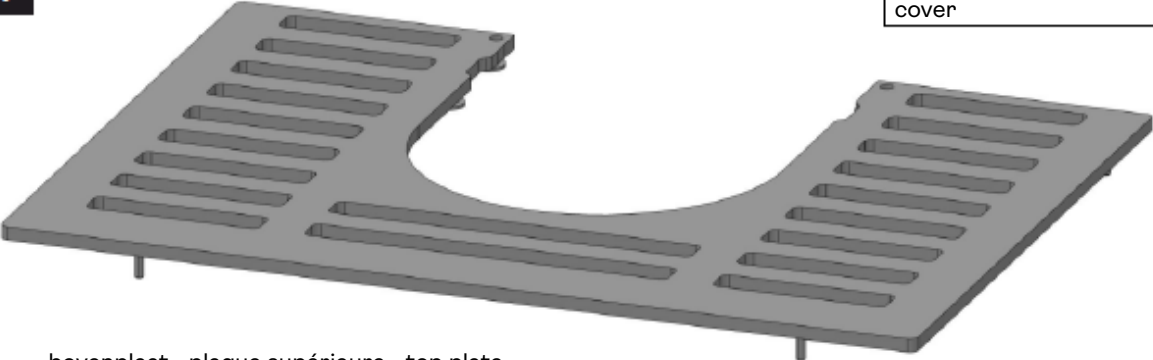
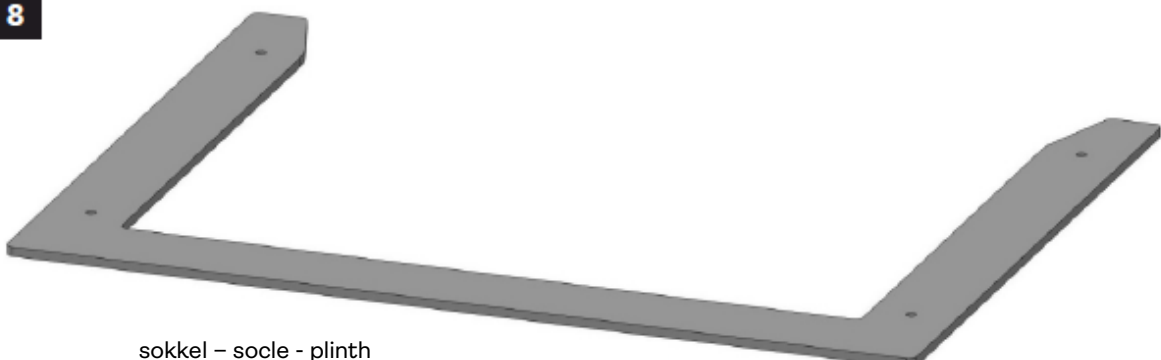
Accessoires – Accessoires - Accessories



<p><b>1</b></p>  <p>beschermende handschoen – gant de protection - protective glove</p>	<p><b>2</b></p>  <p>droogmiddelzakje – sachet déshydratant - dessicant bag</p>	<p><b>3</b></p>  <p>regulator - régulateur - regulator</p>	
<p><b>4</b></p>  <p>bovenplaat - plaque supérieure - top plate</p>	<p><b>5</b></p>  <p>top ring - anneau supérieur - top ring</p>	<p><b>6</b></p>  <p>4x plastic hoes - couvercle en plastique - plastic cover</p>	
<p><b>7</b></p>  <p>bovenplaat - plaque supérieure - top plate</p>			
<p><b>8</b></p>  <p>sokkel – socle - plinth</p>			
<p><b>9</b></p>  <p>4x verstelschroef voor poot M8 vis de réglage du pied M8 leg adjusting screw M8</p>	<p><b>10</b></p>  <p>24x verzonken schroef M6 x 12 vis à tête fraisée M6 x 12 contersunk screw M6 x 12</p>	<p><b>11</b></p>  <p>2x verzonken schroef M4 x 8 vis à tête fraisée M4 x 8 contersunk screw M4 x 8</p>	<p><b>12</b></p>  <p>cover - couverture - cover</p>

**13**



roosterhaak – crochet pour grille - grate hook

**14**



3m

afdichting 8 x 2- joint 8 x 2 - gasket 8 x 2

**15**



montagehulp – dispositif d'assemblage - assembly aid

**16**

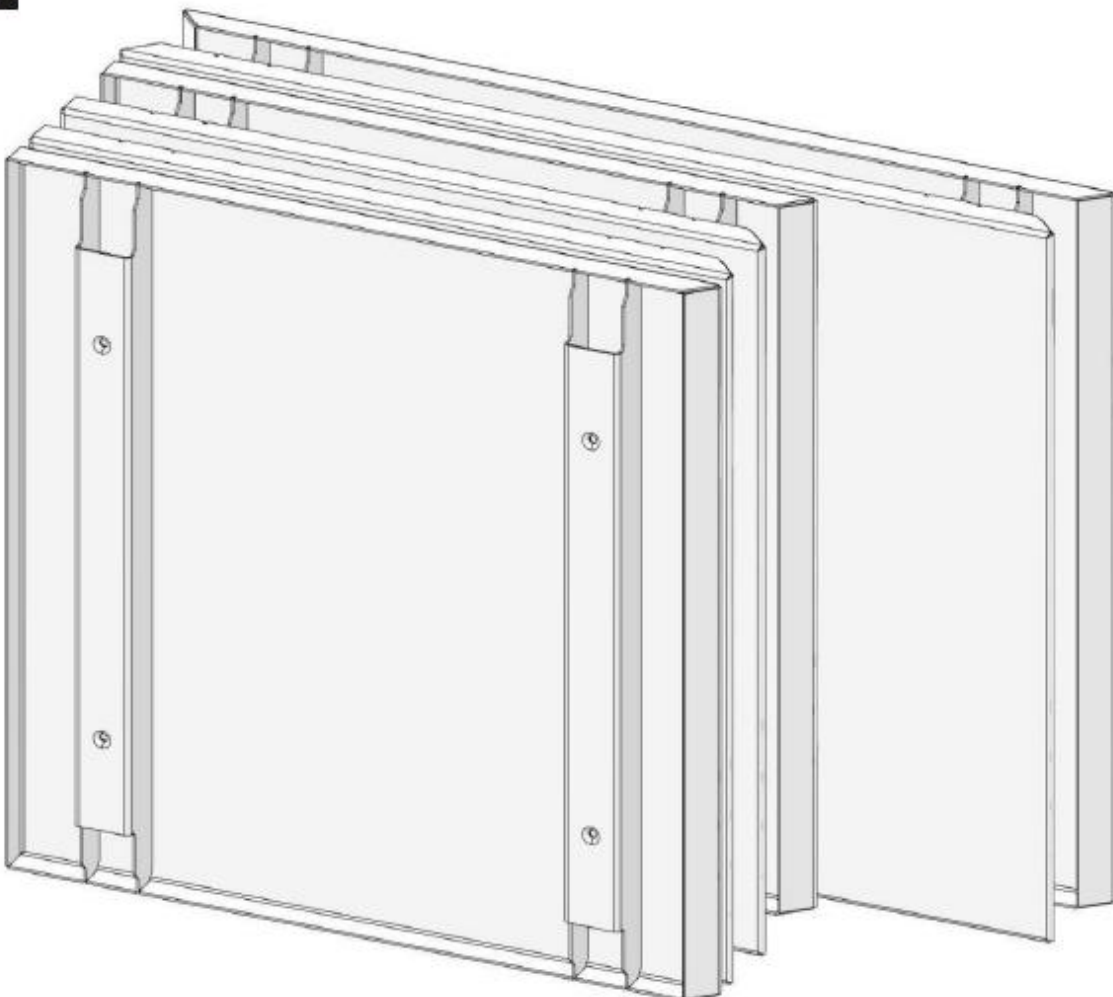

plaatstaal – tôle d'acier - sheet steel

## Aansluitmogelijkheden - Options de connexion - Connection options

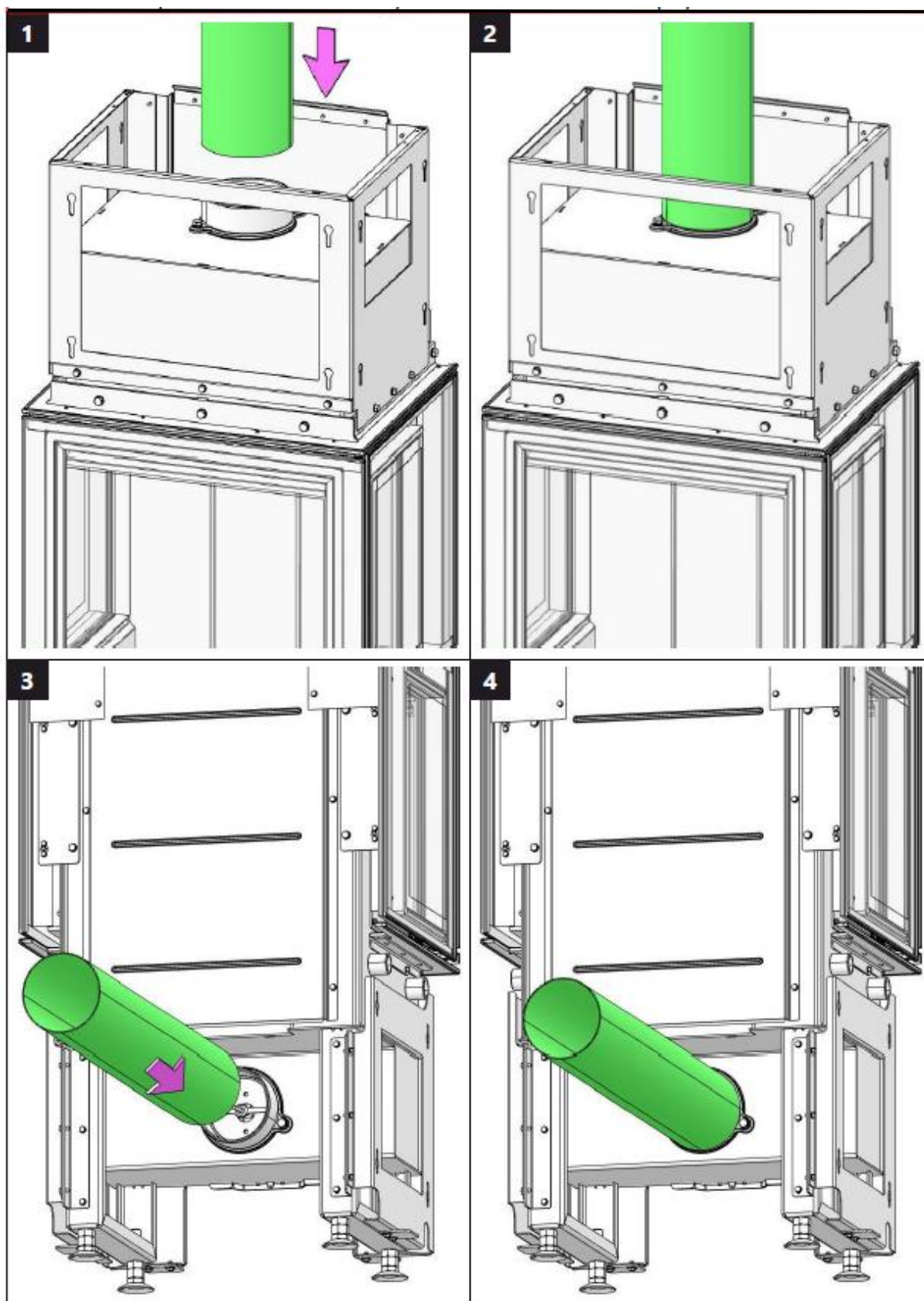

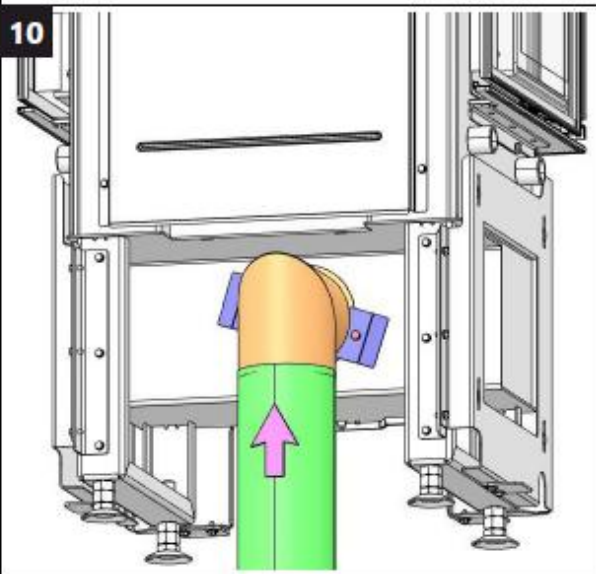
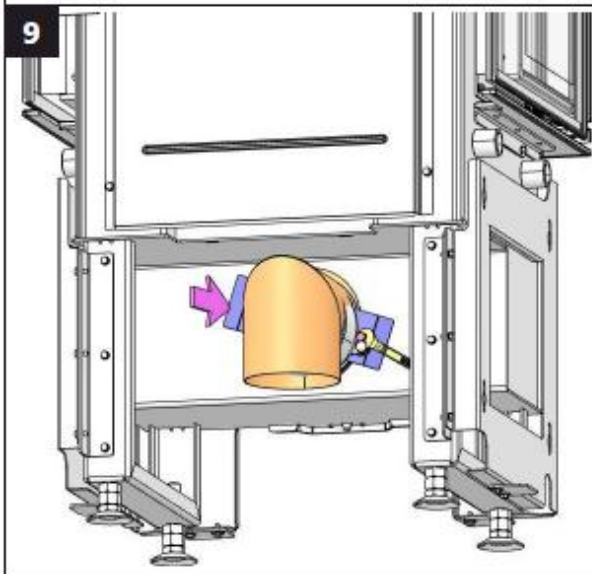
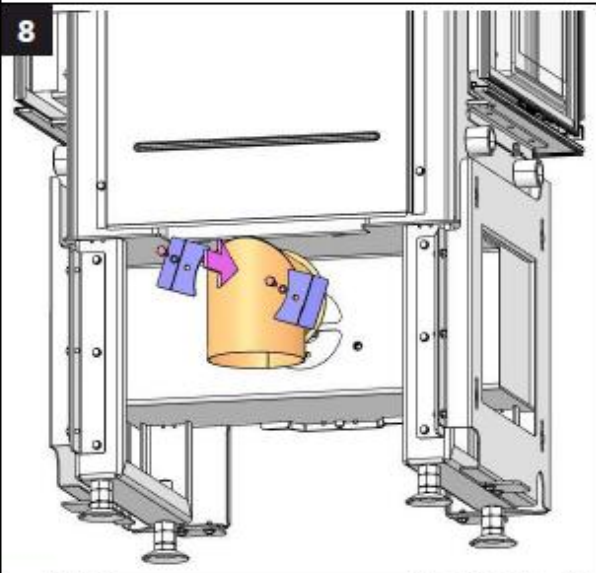
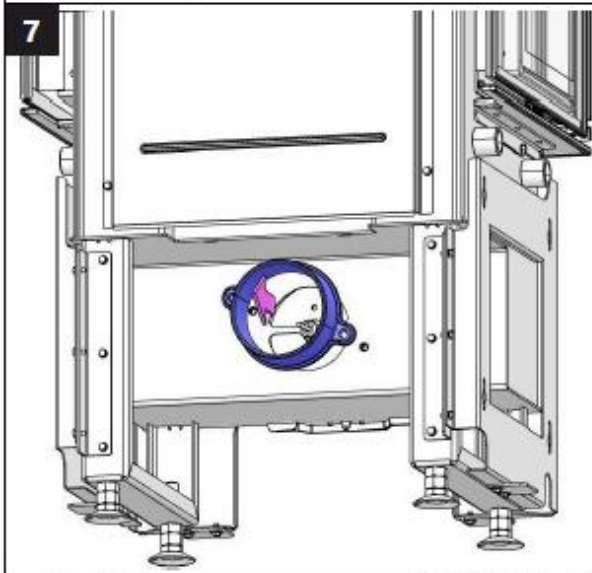
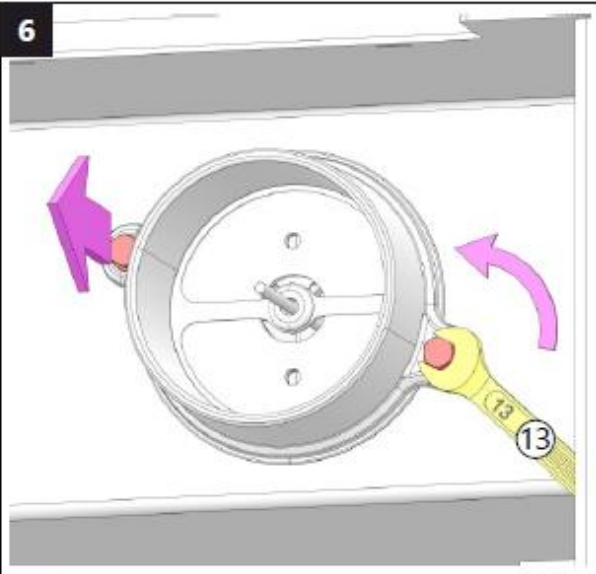
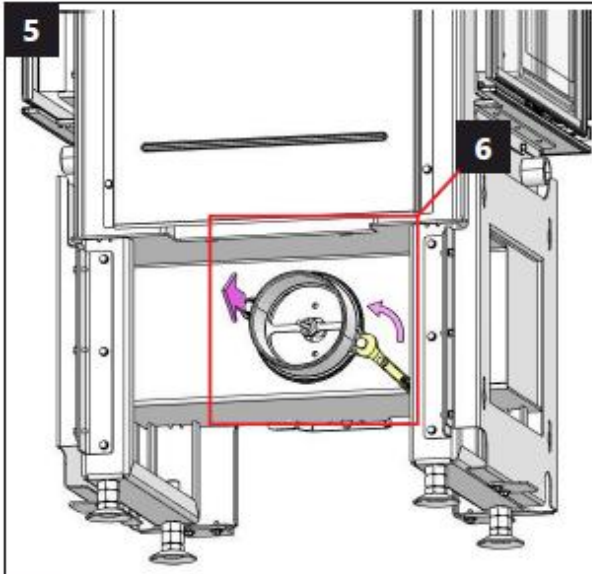

Bekleding montage – Ensemble de bardage - Cladding assembly

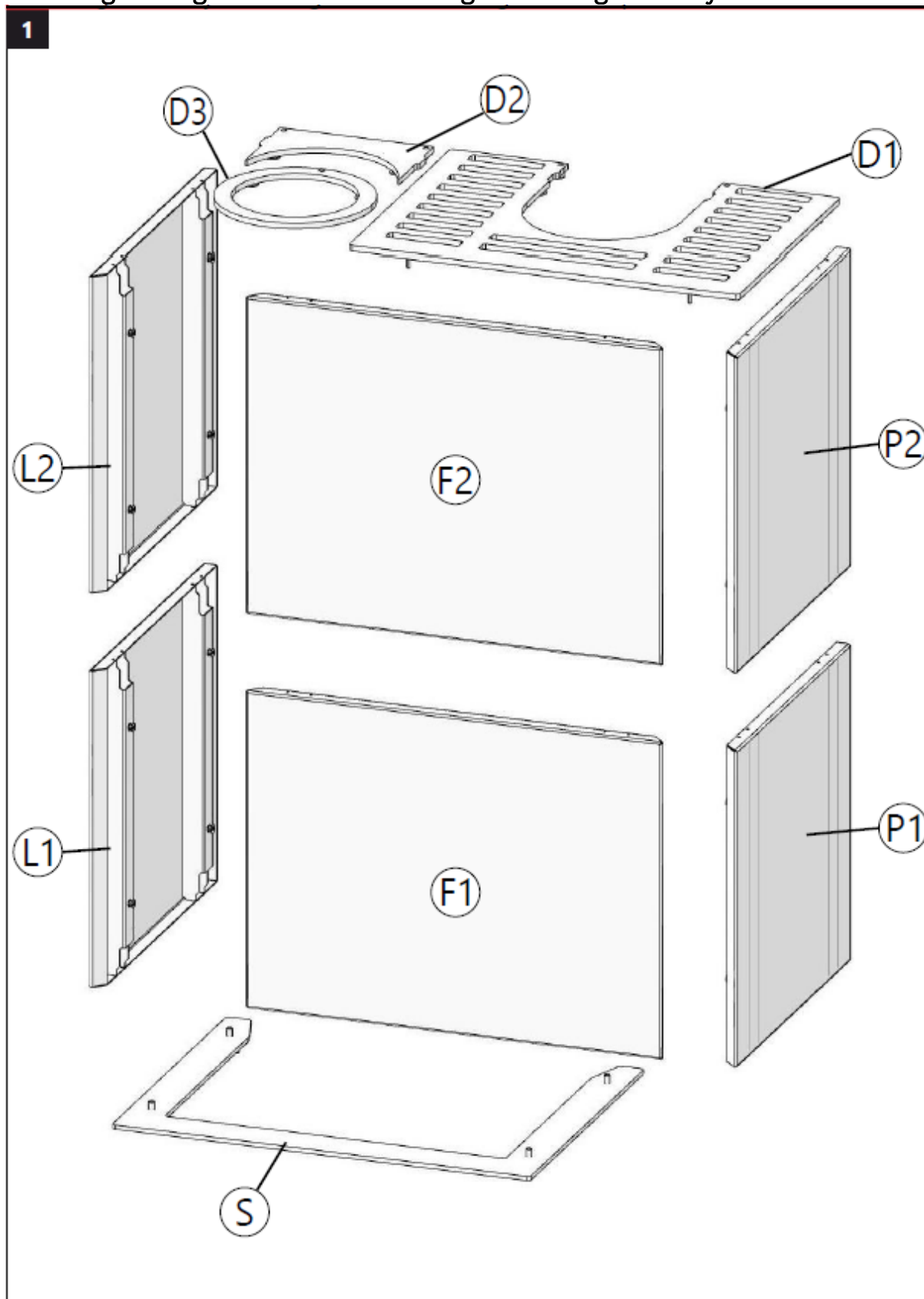

2

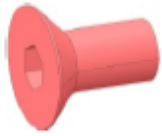

M6x12 24x

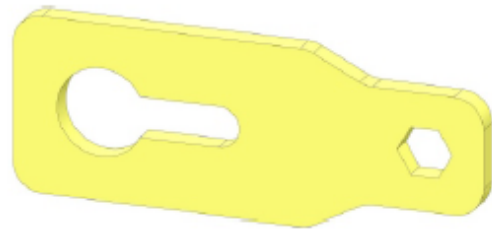

3

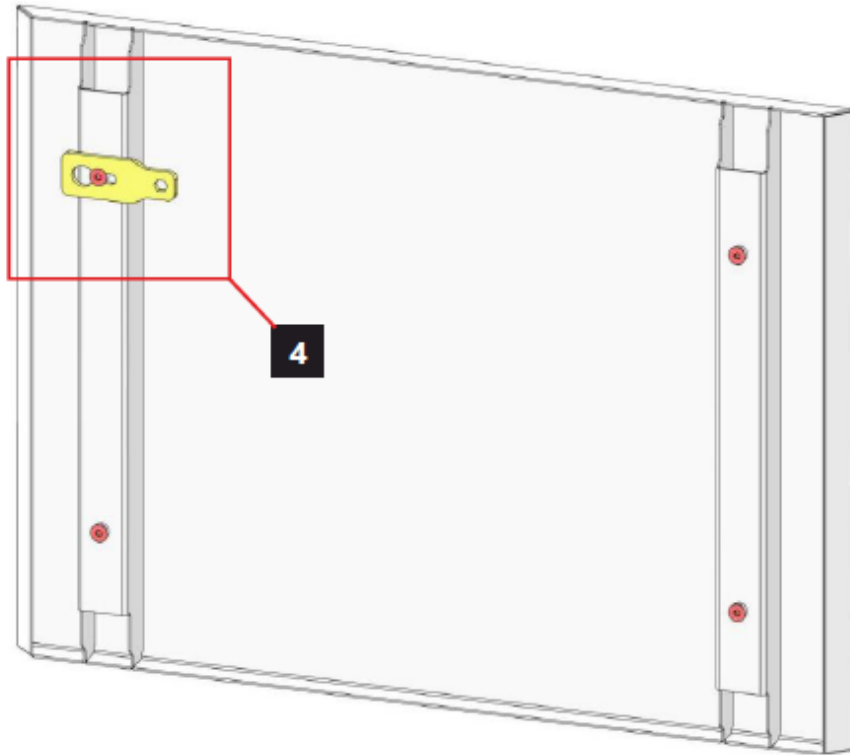

4

4

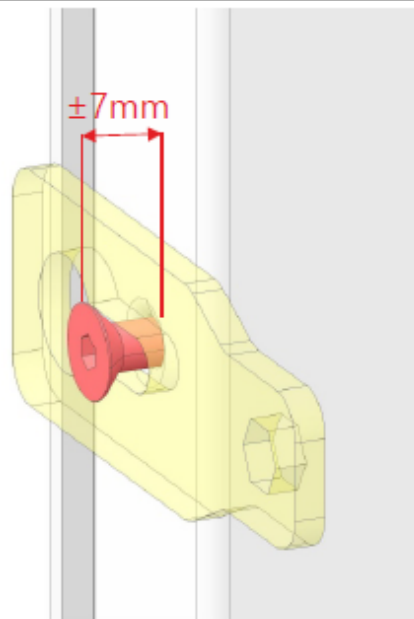

$\pm 7\text{mm}$

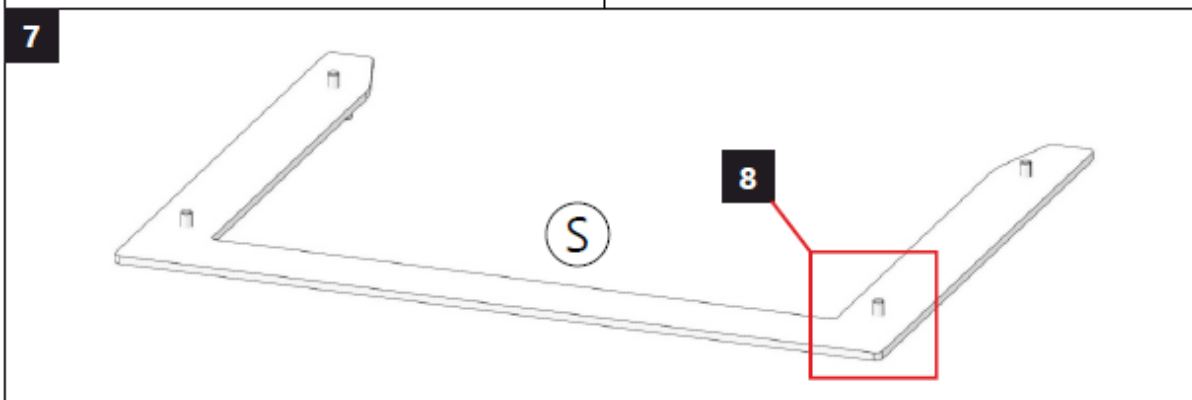
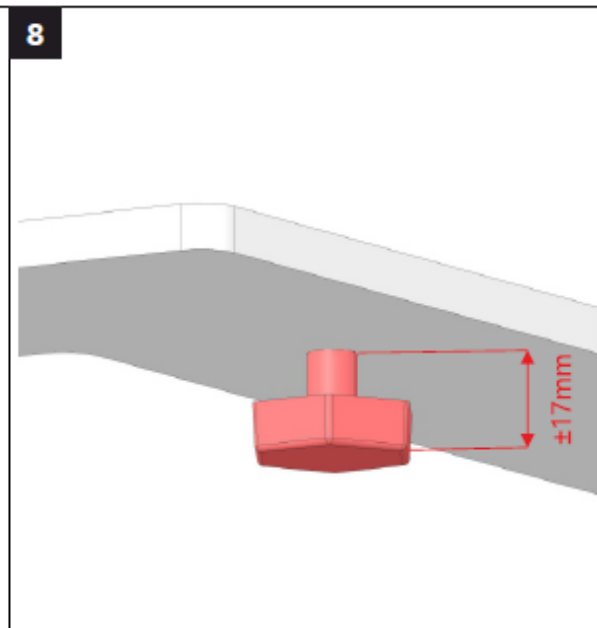
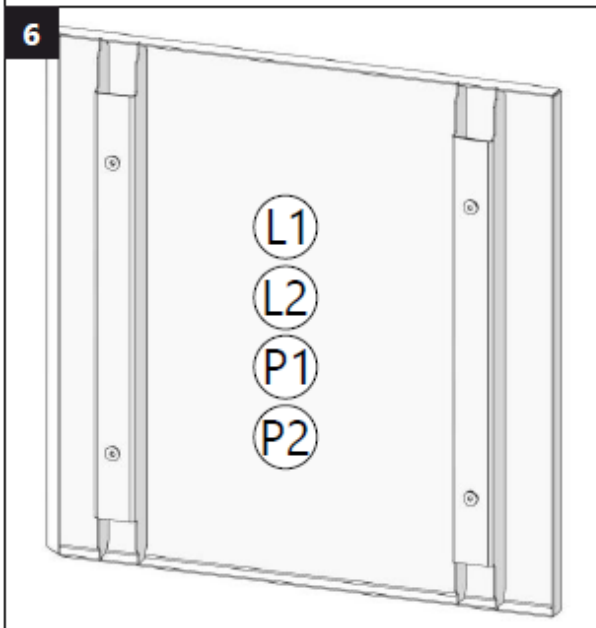
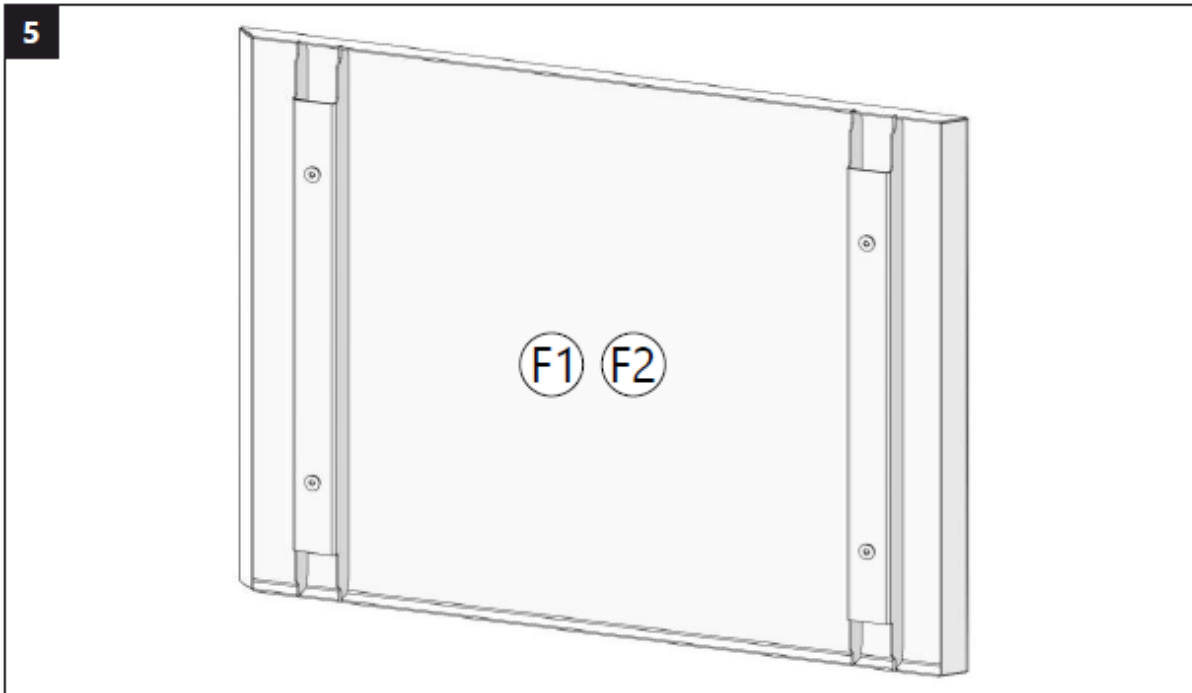

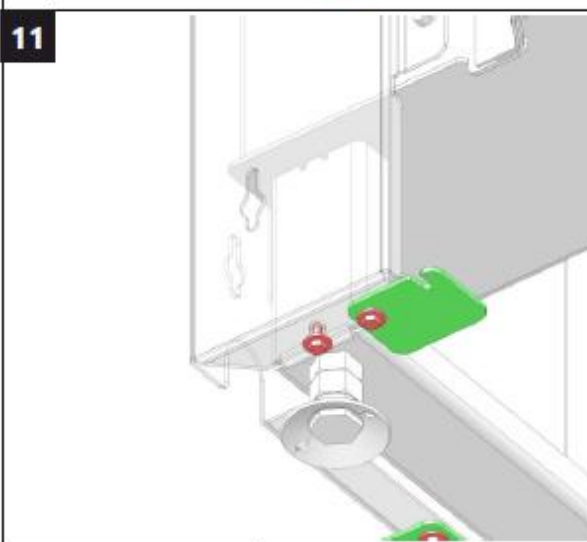
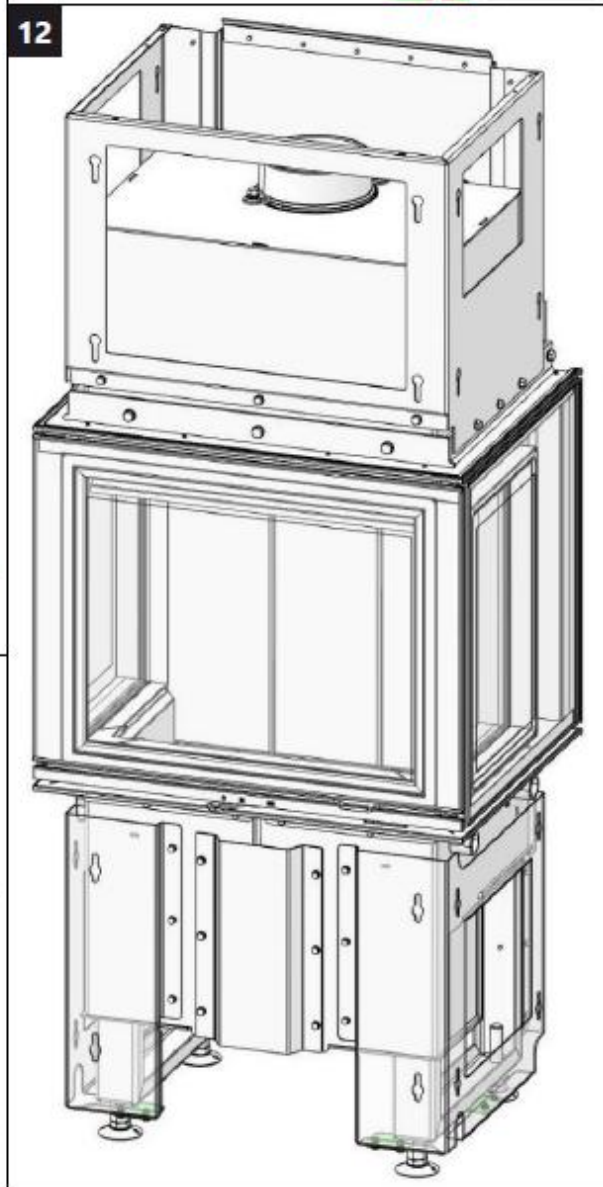
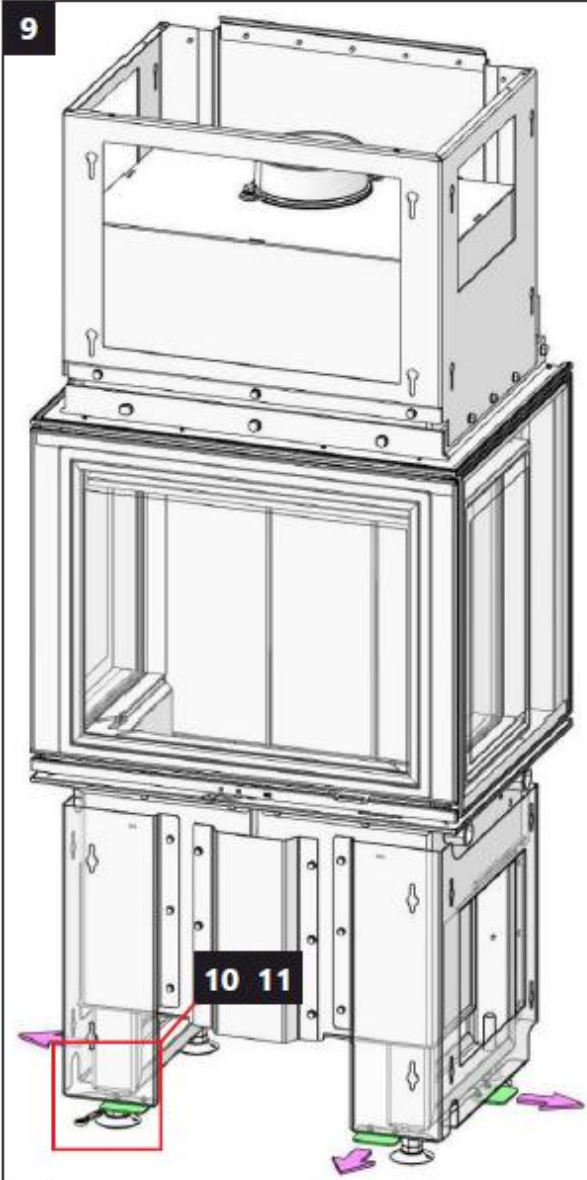

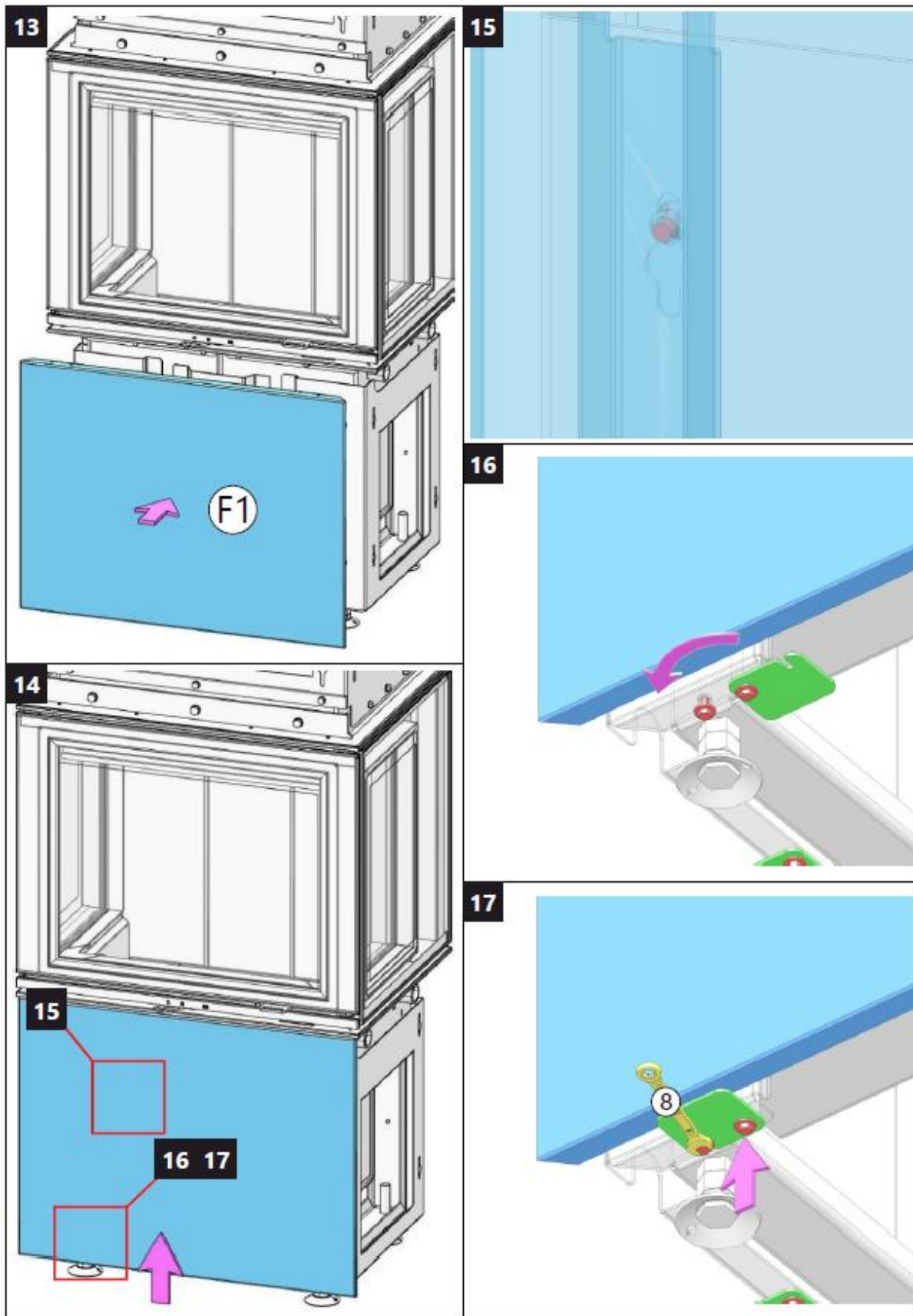

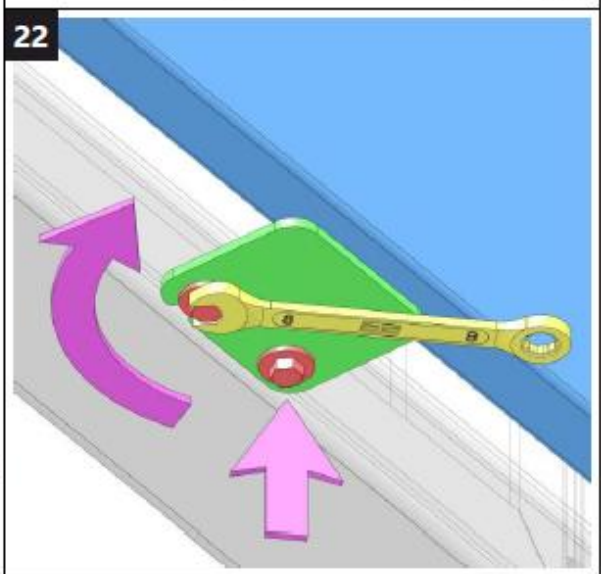
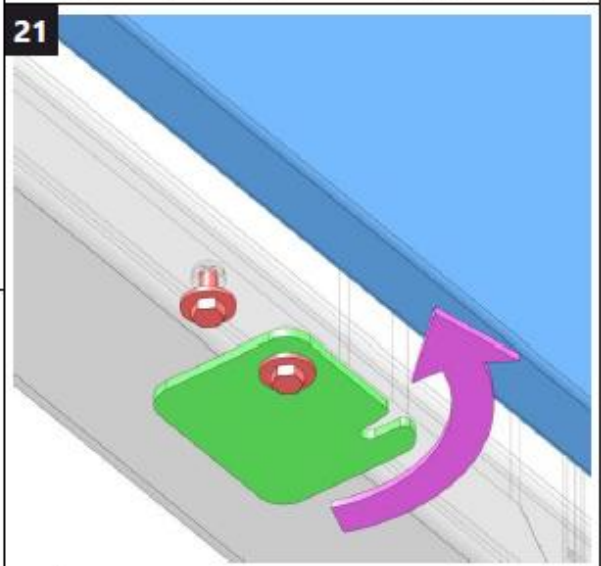
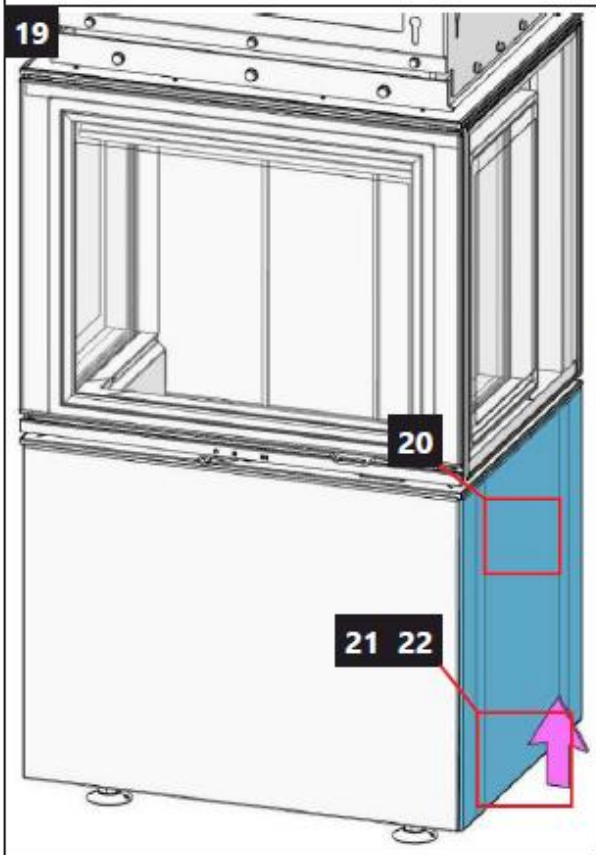
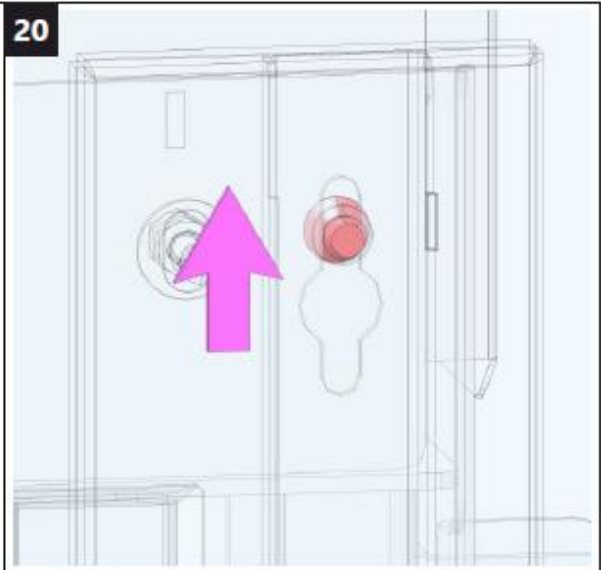
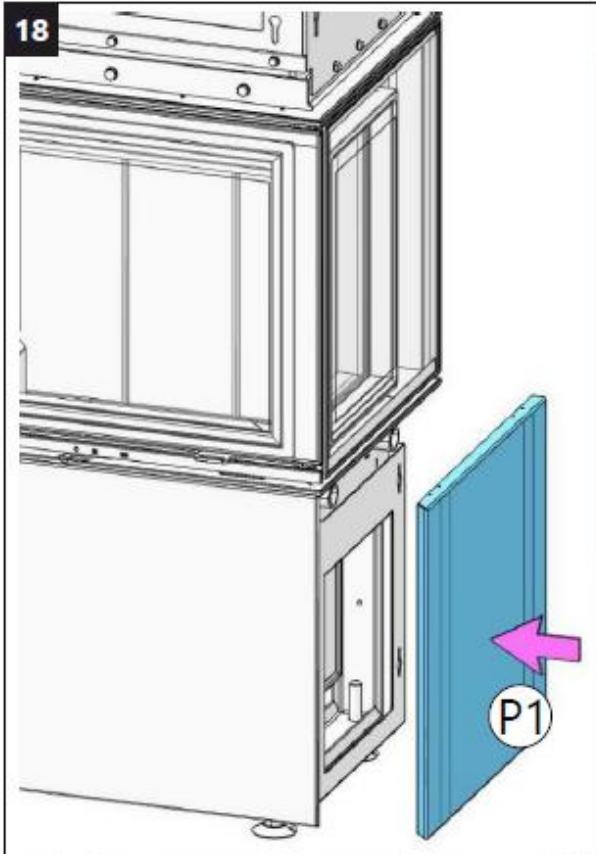

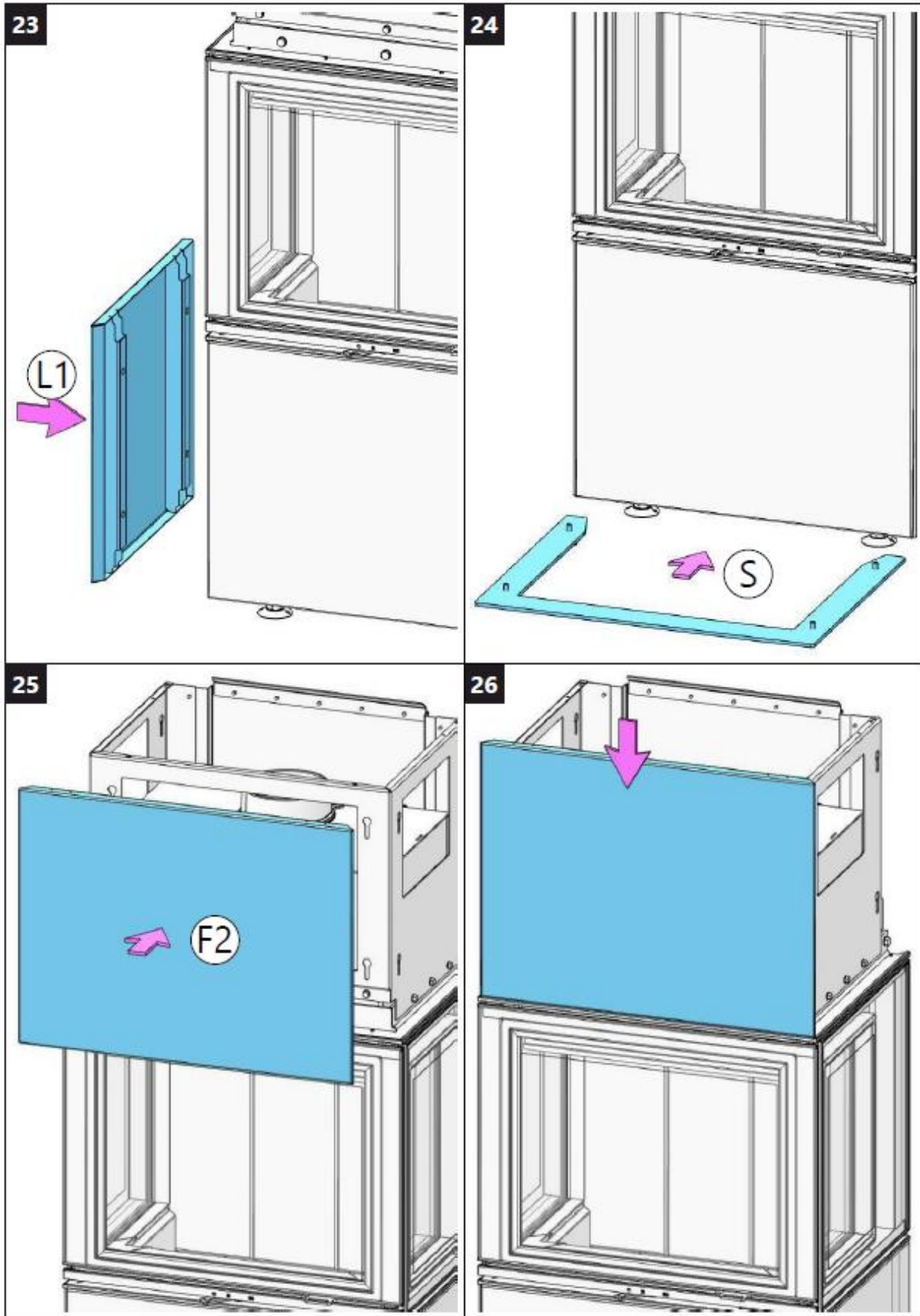

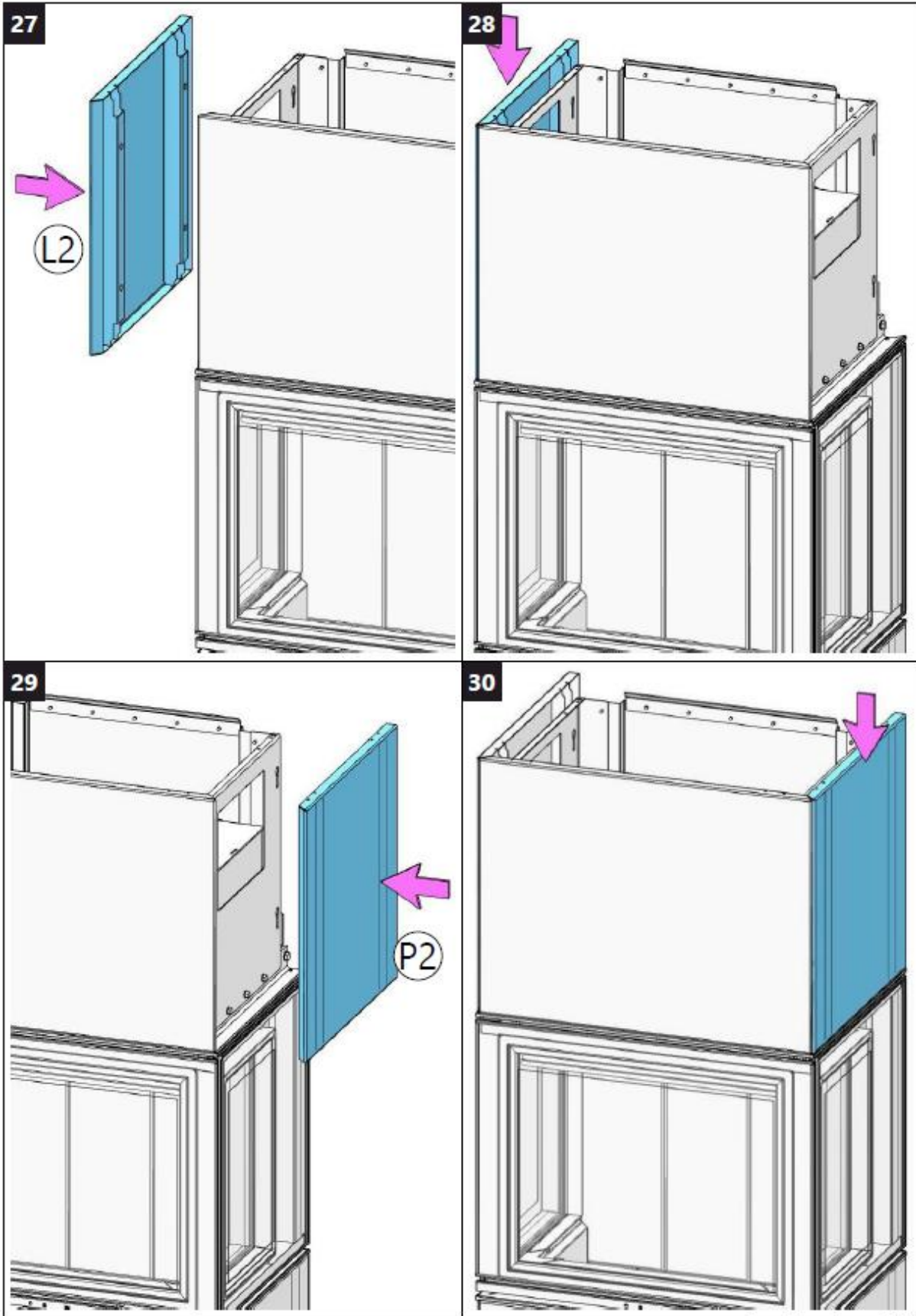

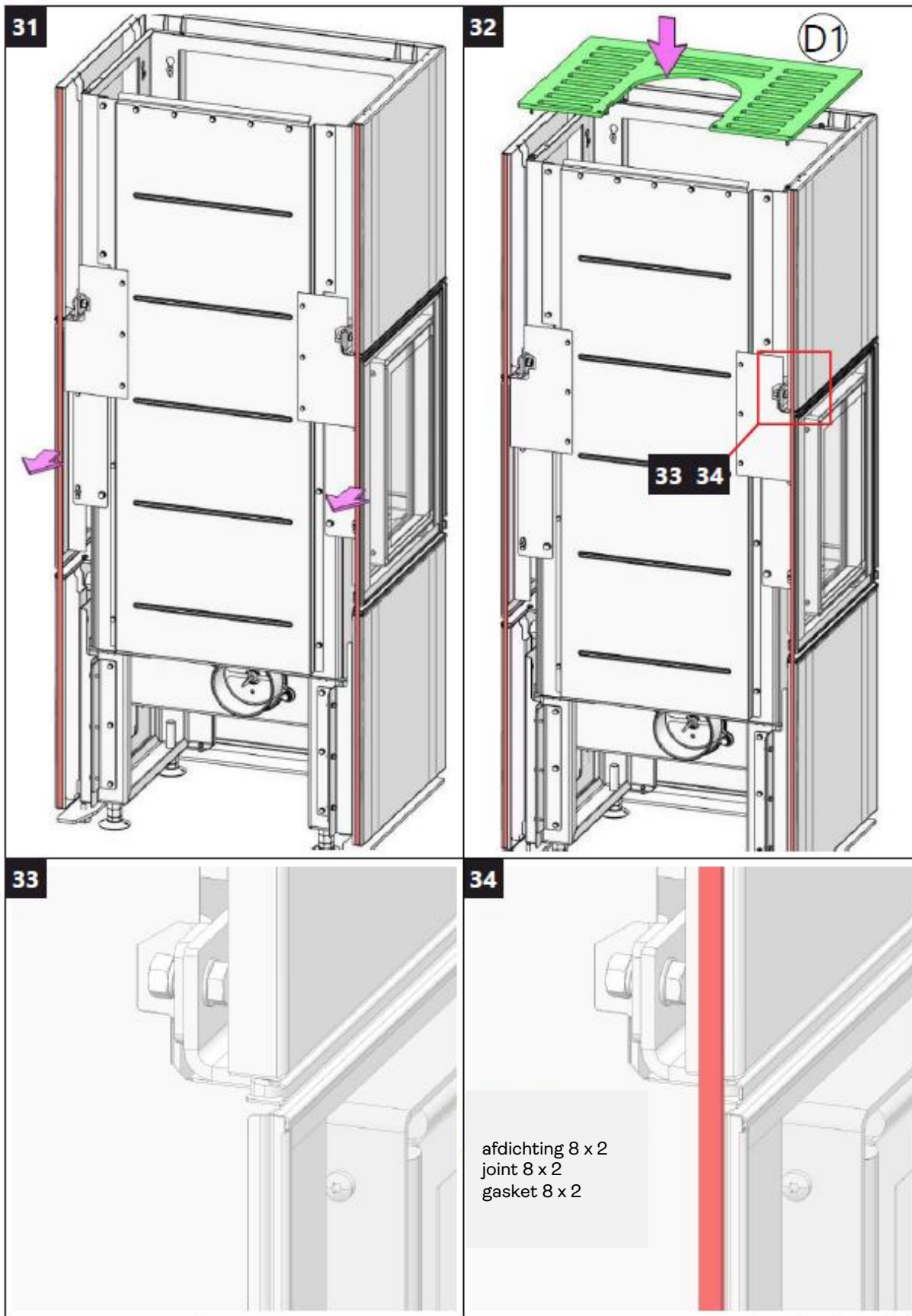

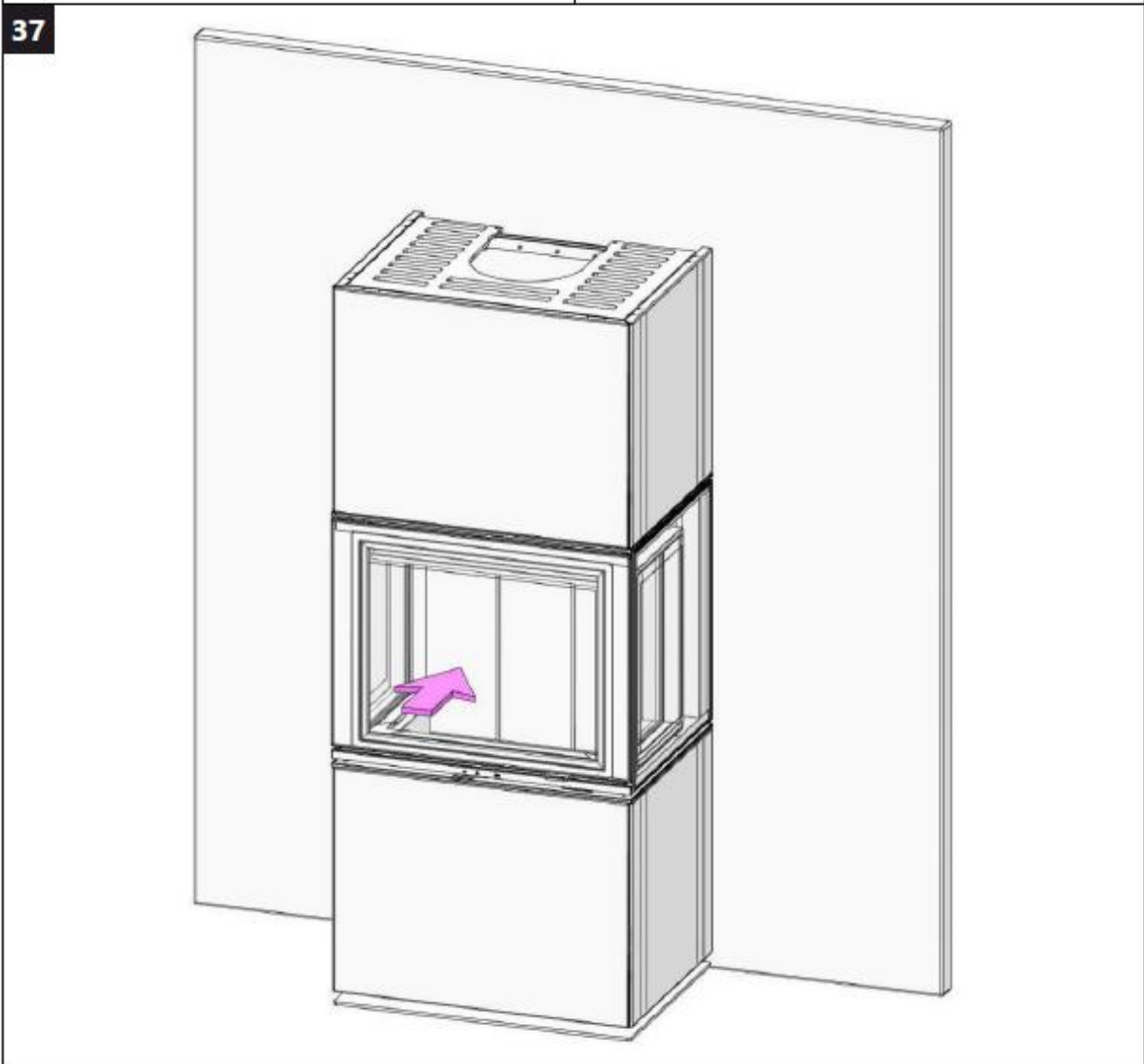
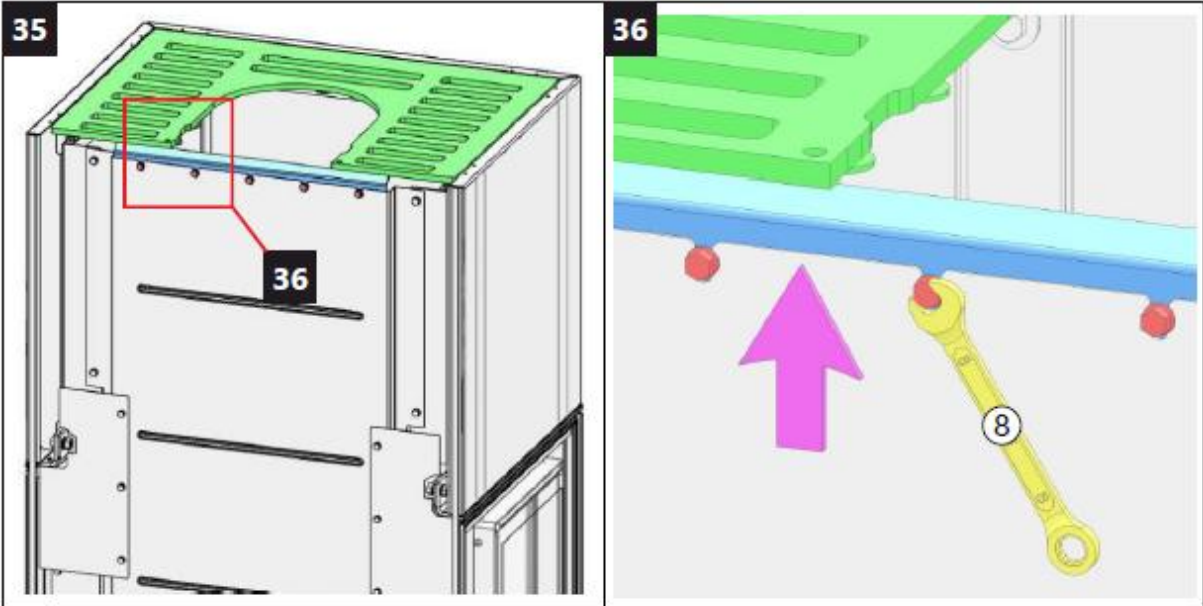

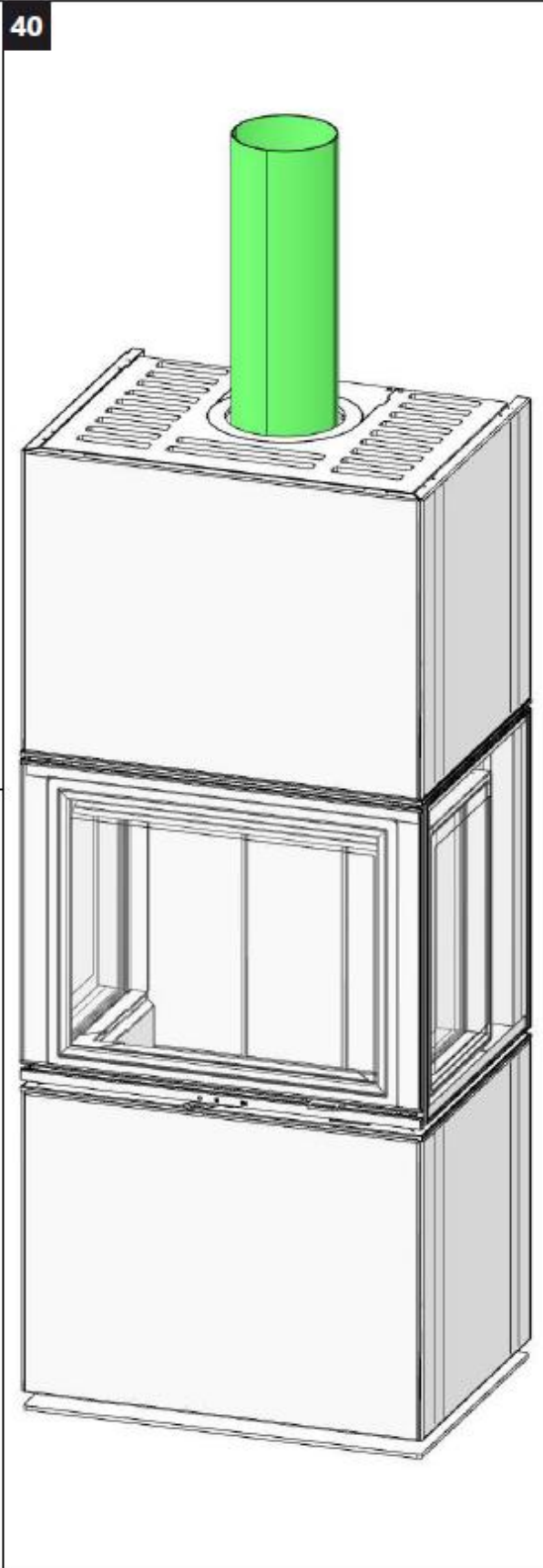
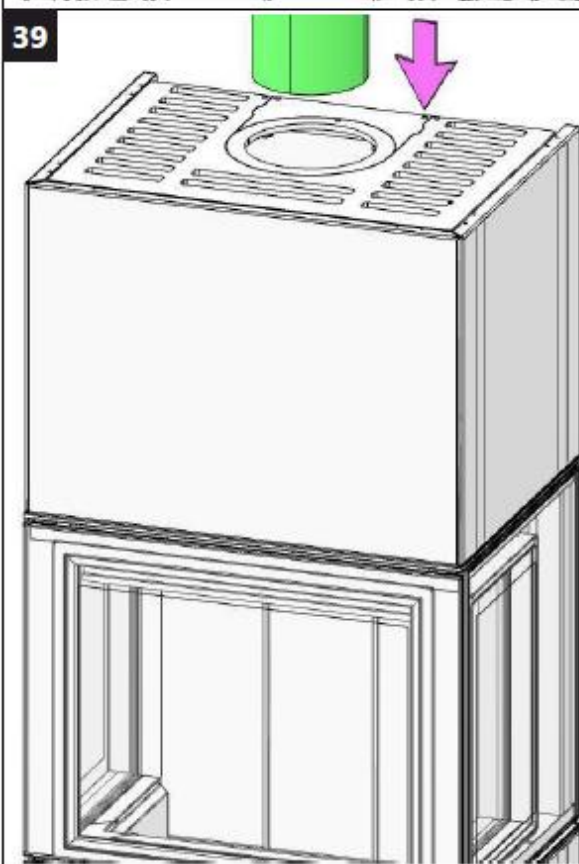
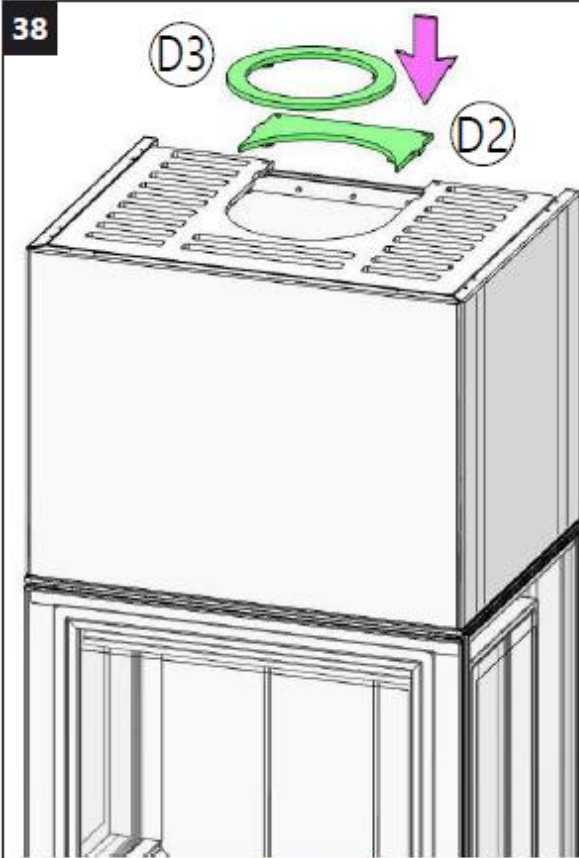

## Vuurvaste kamer - Chambre en argile réfractaire - Fireclay chamber

1

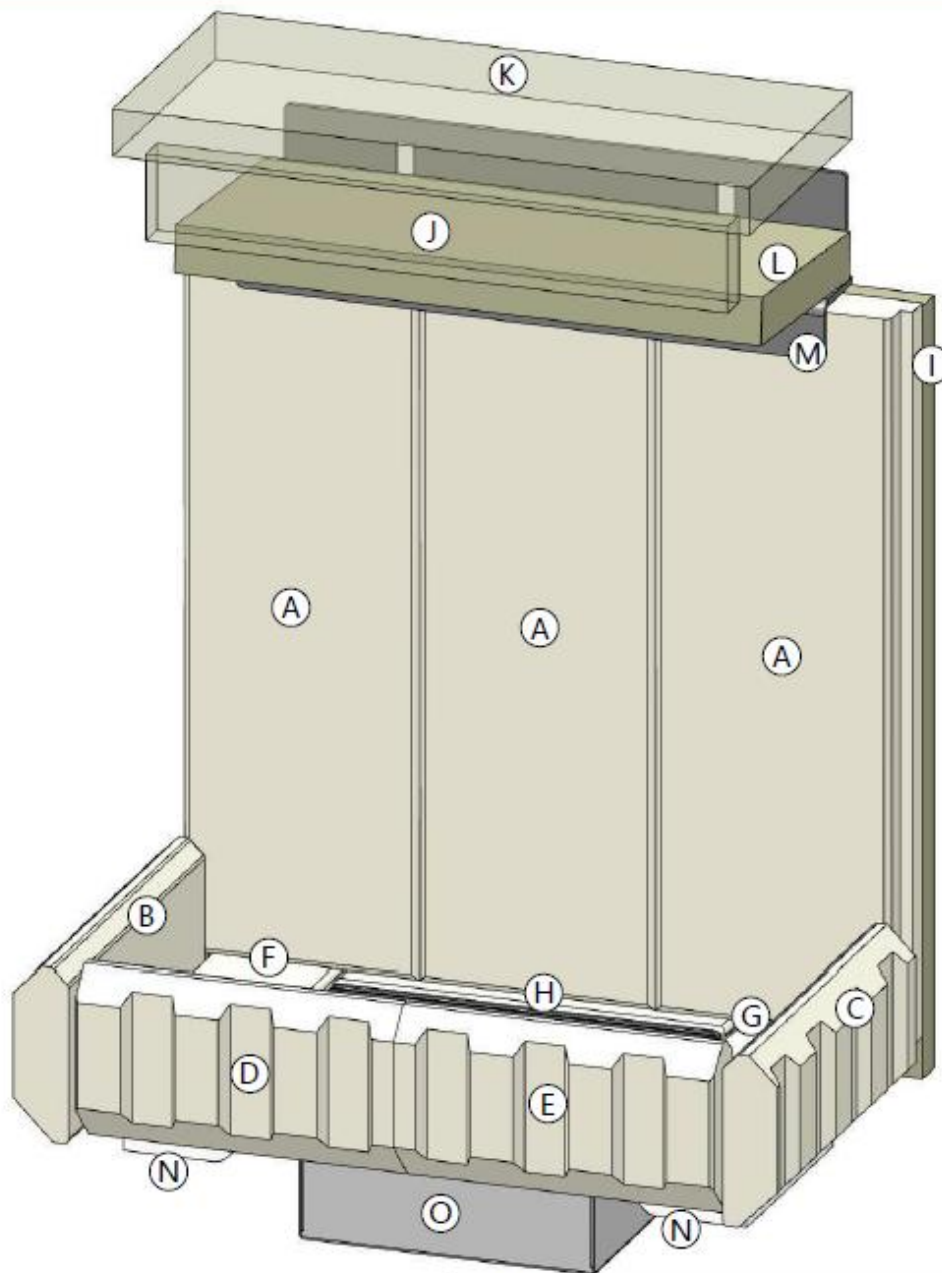

Ⓐ Ⓑ Ⓒ Ⓓ	chamottesteen – brique de chamotte – chamotte brick	
Ⓔ Ⓕ Ⓖ Ⓗ		
Ⓘ	vermiculiet- vermiculite - vermiculite	20 x 233 x 490
Ⓝ	vermiculiet- vermiculite - vermiculite	20 x 55 x 370
Ⓚ	vermiculiet- vermiculite - vermiculite	30 x 180 x 405
Ⓛ	vermiculiet- vermiculite - vermiculite	30 x 195 x 373
Ⓜ	dakplaat baksteenhouder - support de tuile - roof plate brick holder	
Ⓝ	isolatiemat - tapis isolant - insulating mat	
Ⓞ	aslade - tiroir à cendres - ashtray	
Ⓟ	rooster – grille - grate	

2

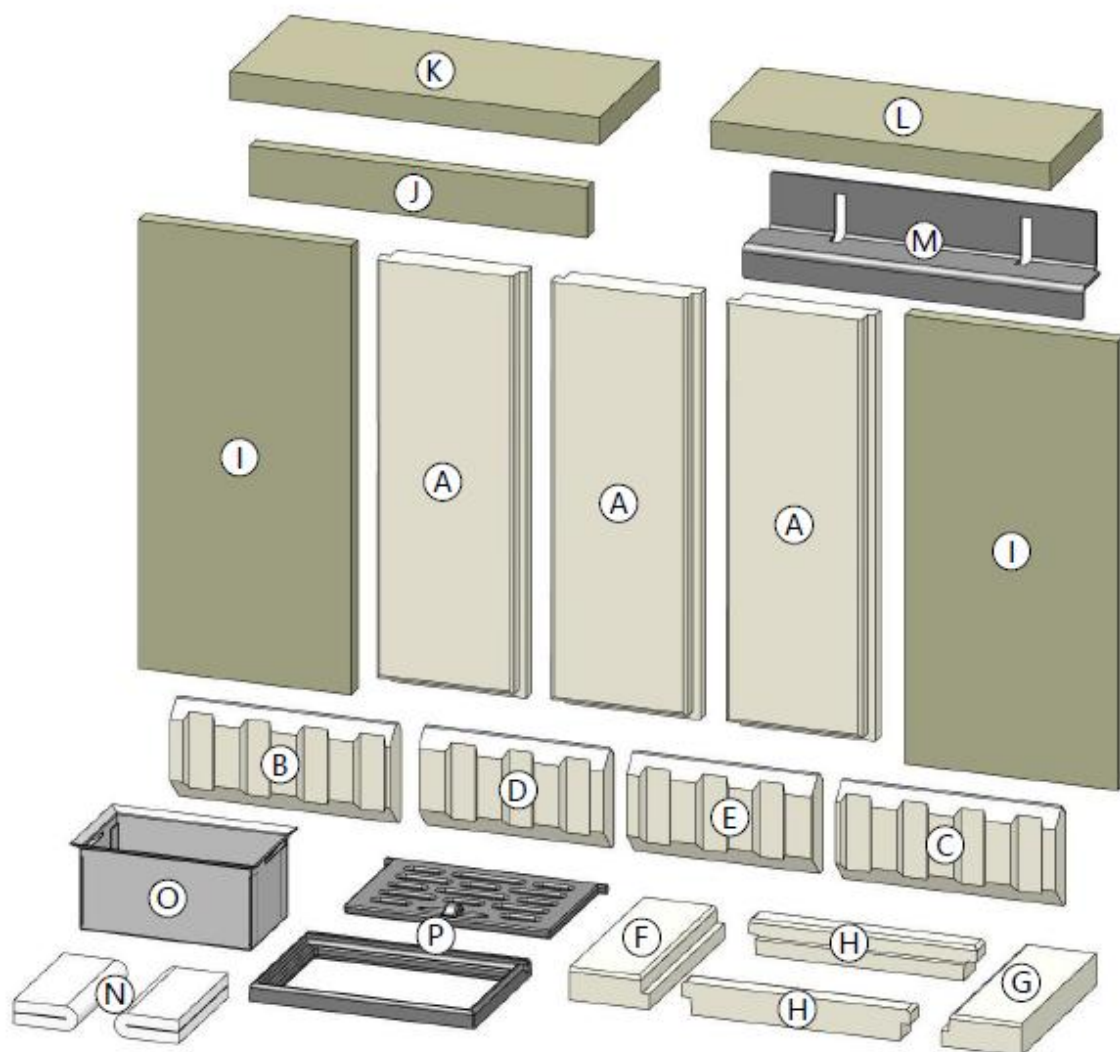

(A)(B)(C)(D) (E)(F)(G)(H)	chamottestein – brique de chamotte – chamotte brick	
(I)	vermiculiet- vermiculite - vermiculite	20 x 233 x 490
(J)	vermiculiet- vermiculite - vermiculite	20 x 55 x 370
(K)	vermiculiet- vermiculite - vermiculite	30 x 180 x 405
(L)	vermiculiet- vermiculite - vermiculite	30 x 195 x 373
(M)	dakplaat baksteenhouder - support de tuile - roof plate brick holder	
(N)	isolatiemat - tapis isolant - insulating mat	
(O)	aslade - tiroir à cendres - ashtray	
(P)	rooster – grille - grate	

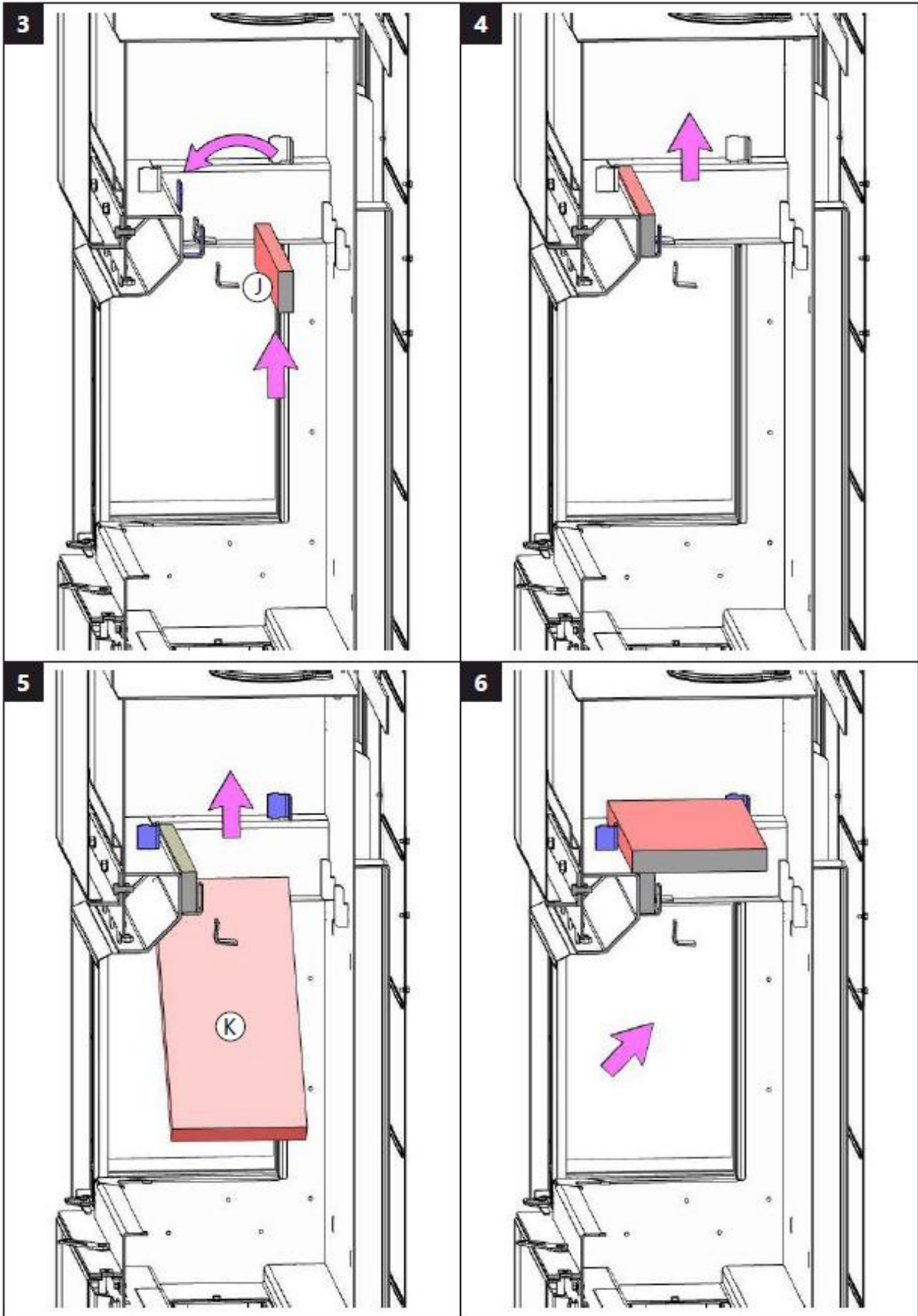

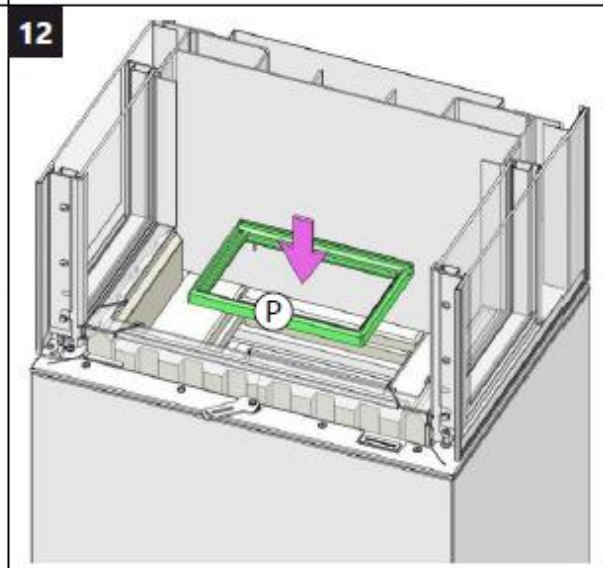
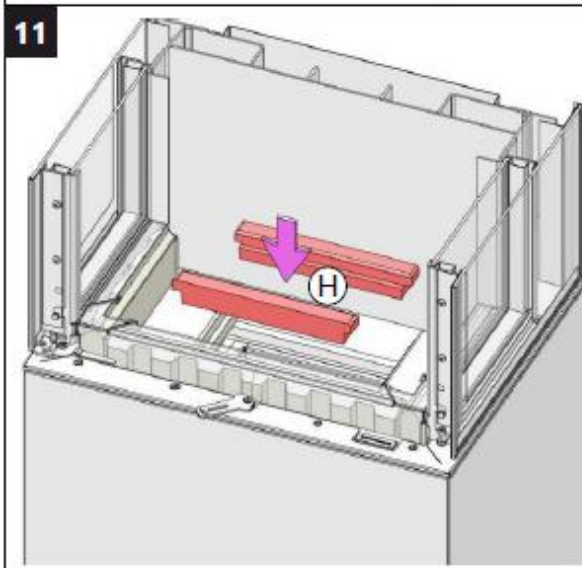
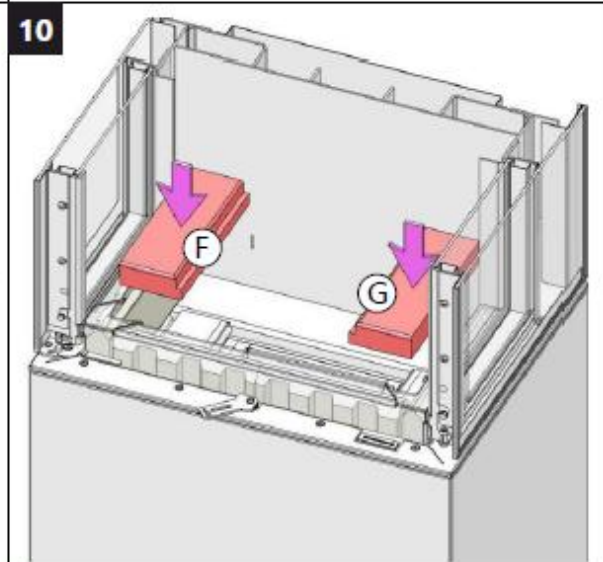
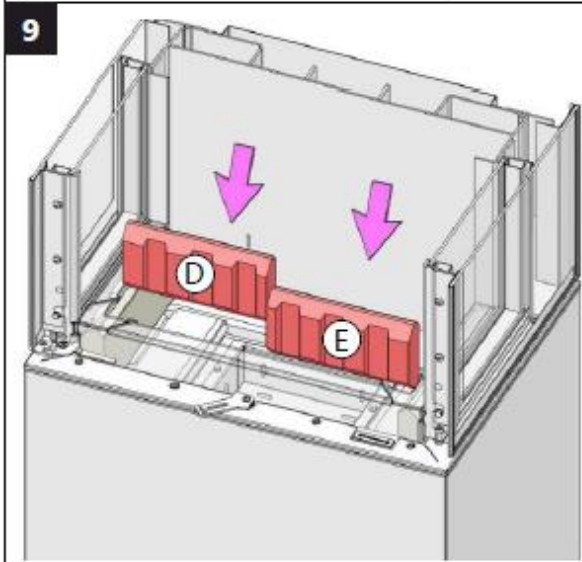
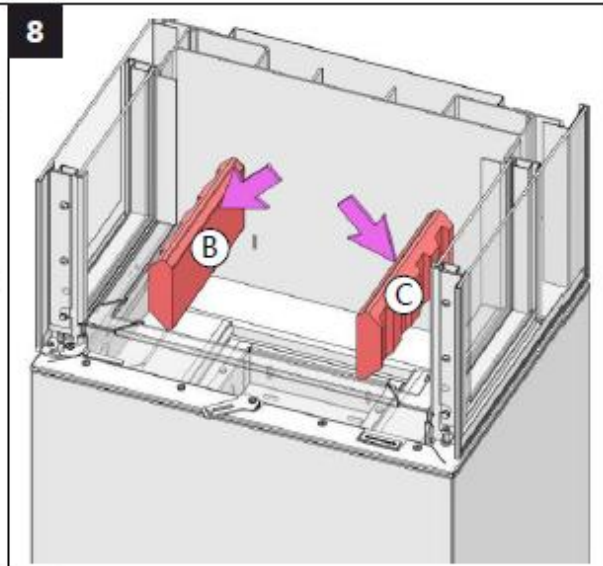
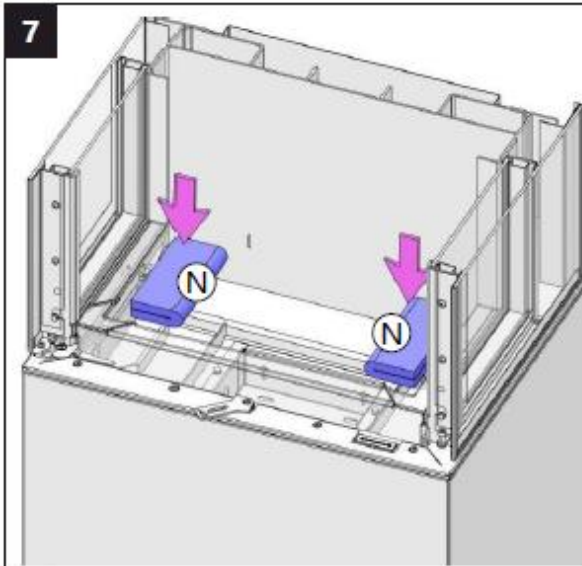

13

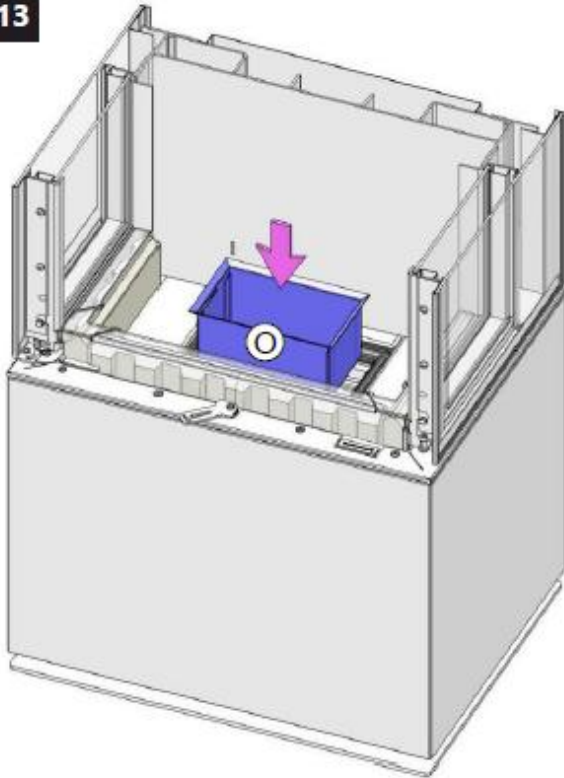

14

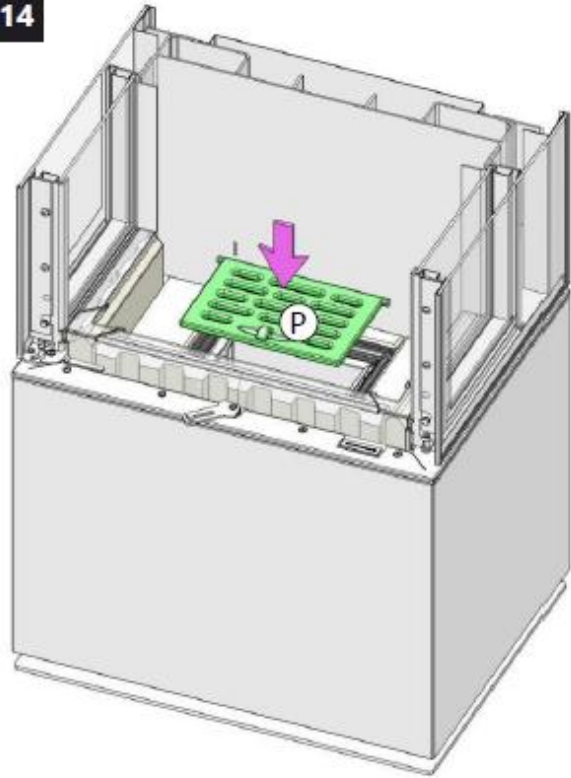

15

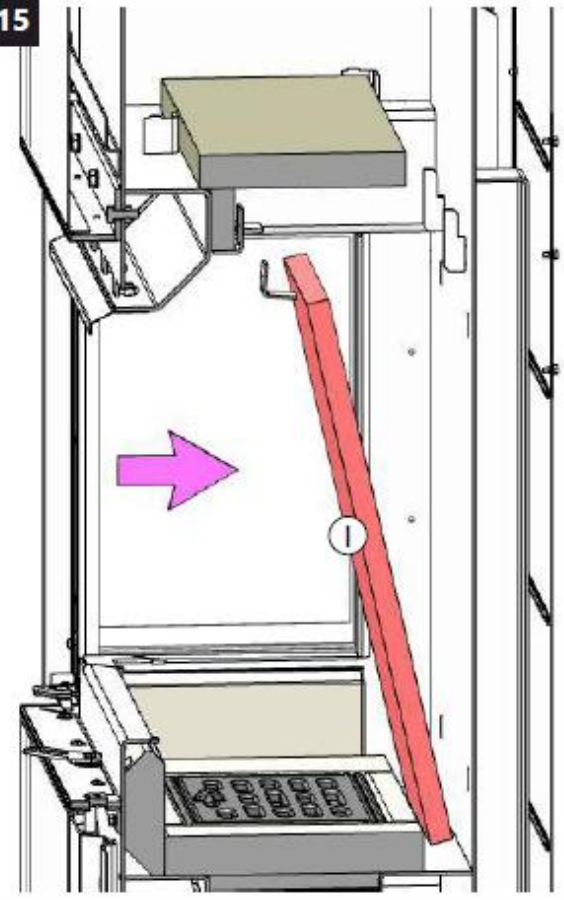

16

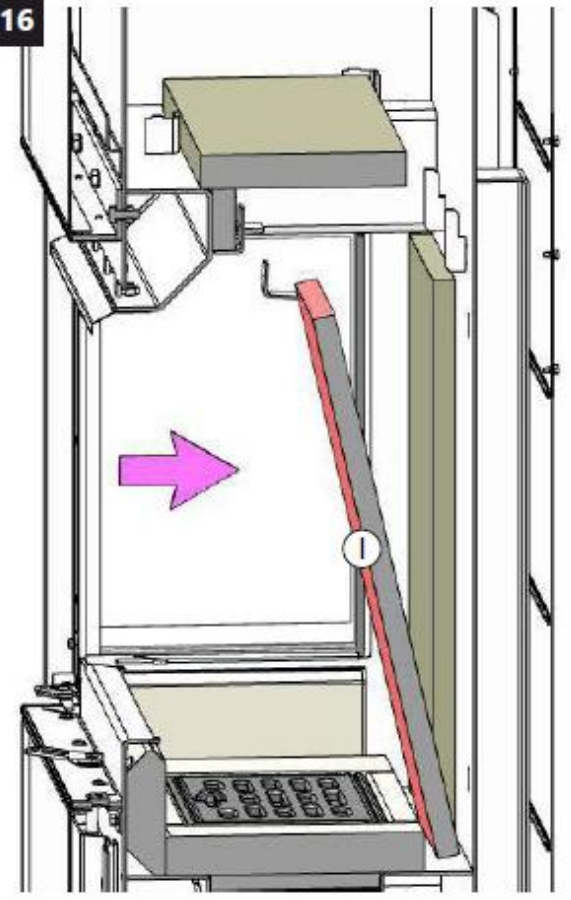

17

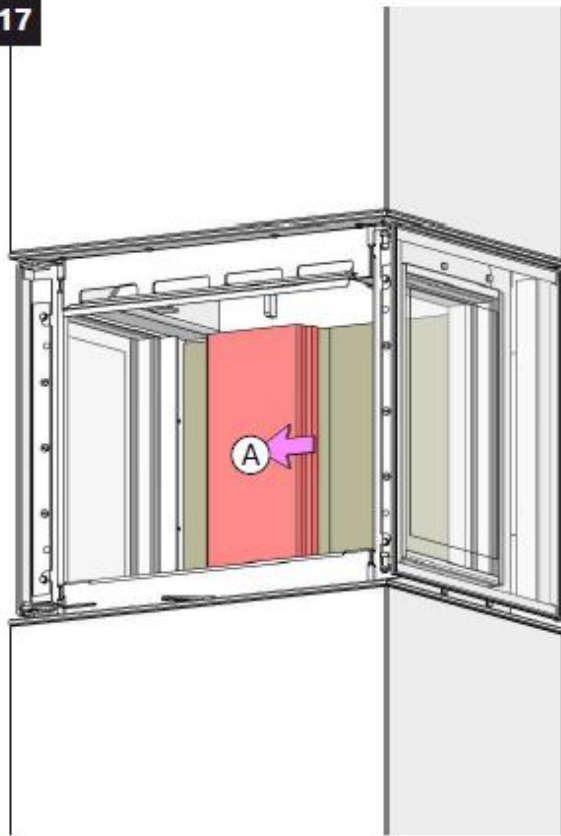

18

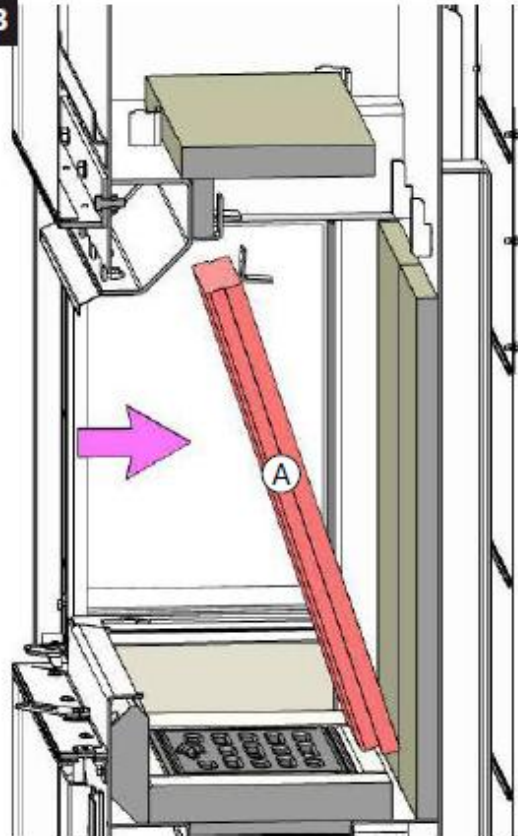

19

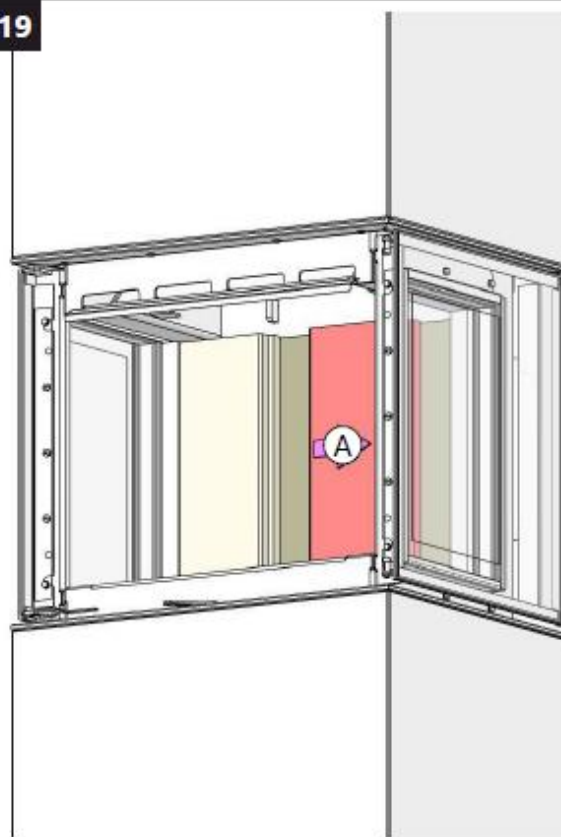

20

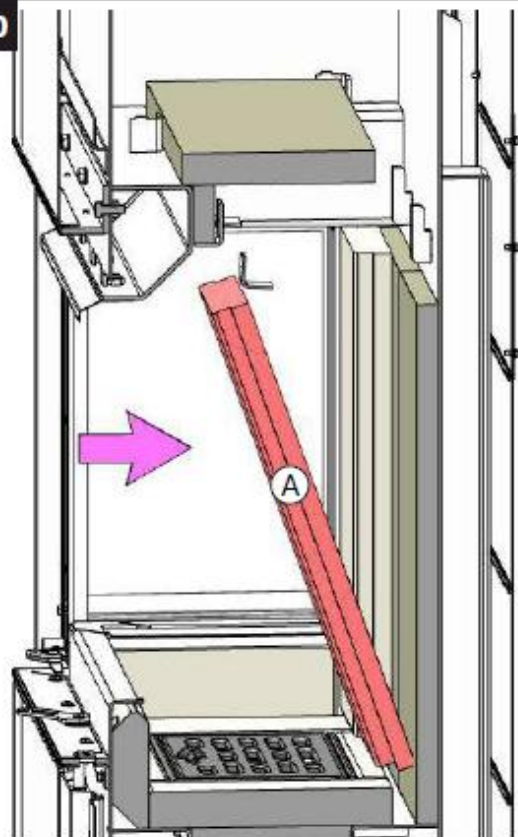

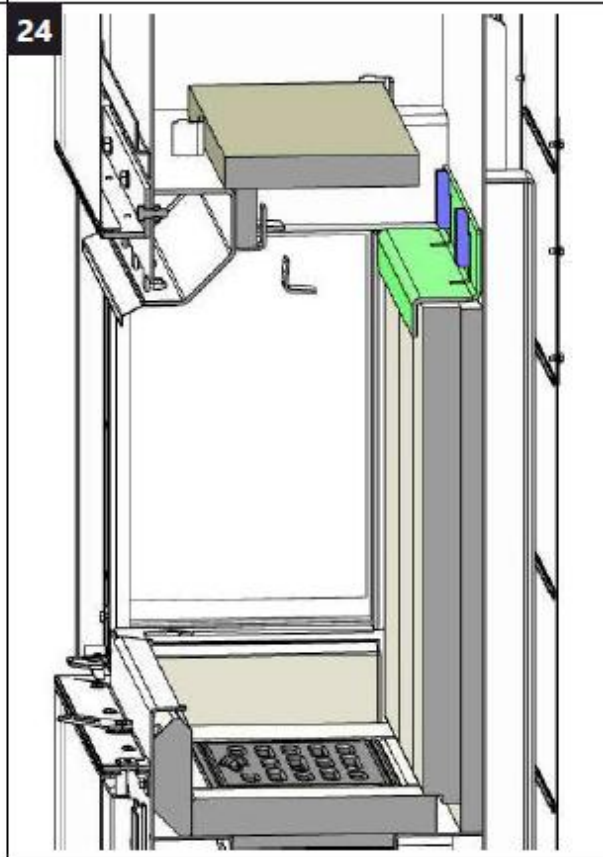
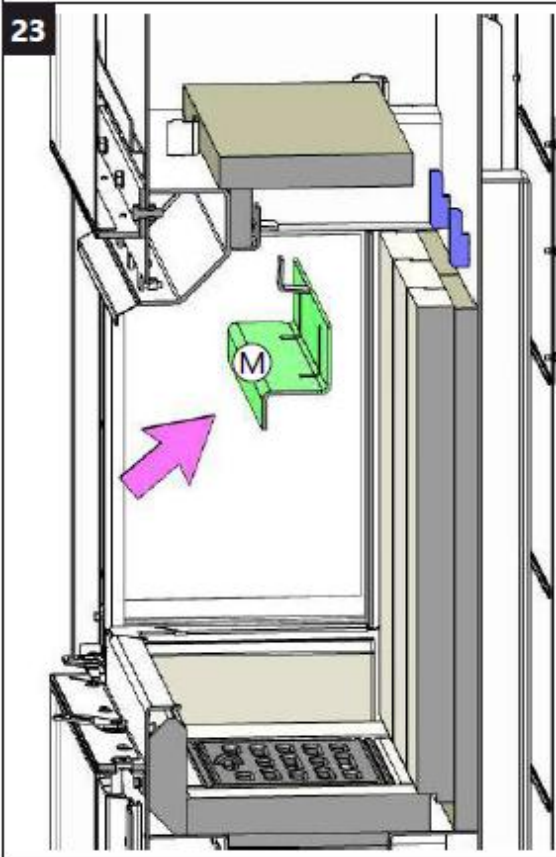
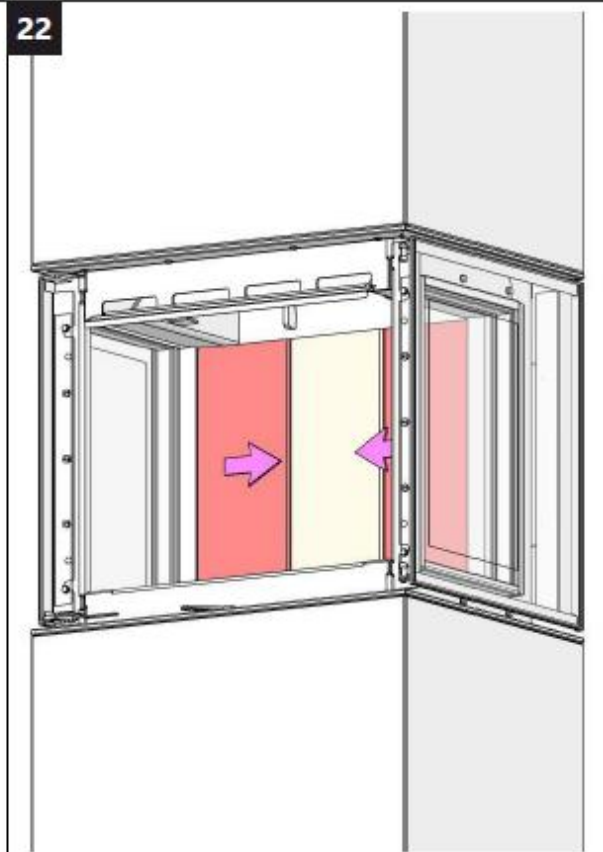
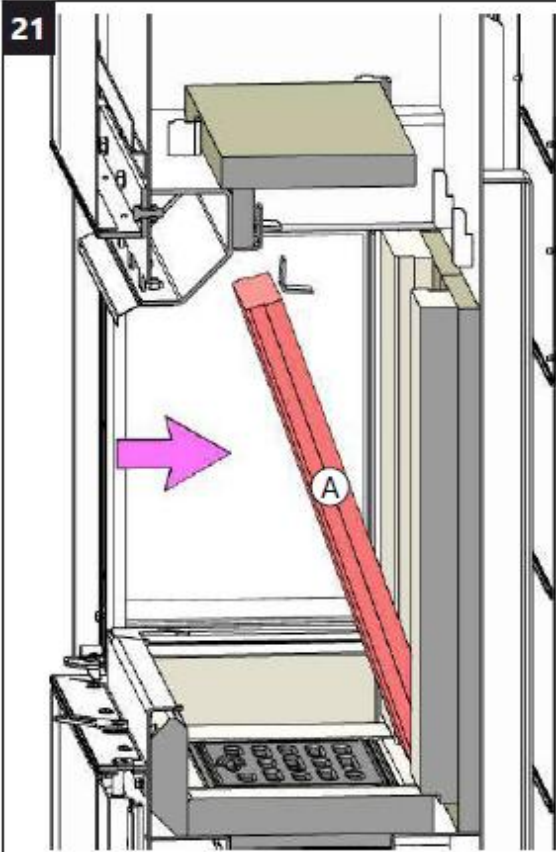

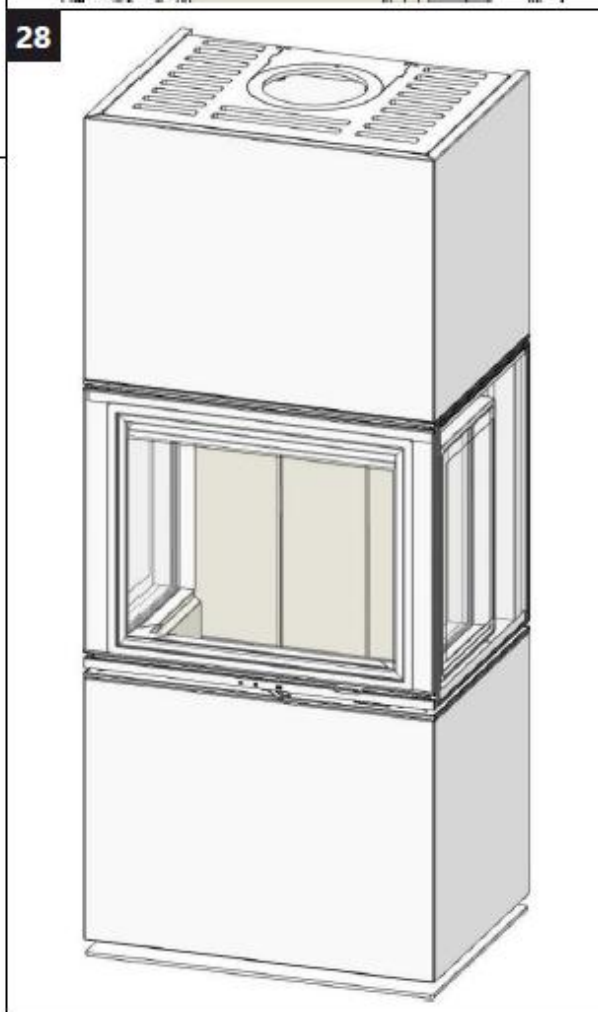
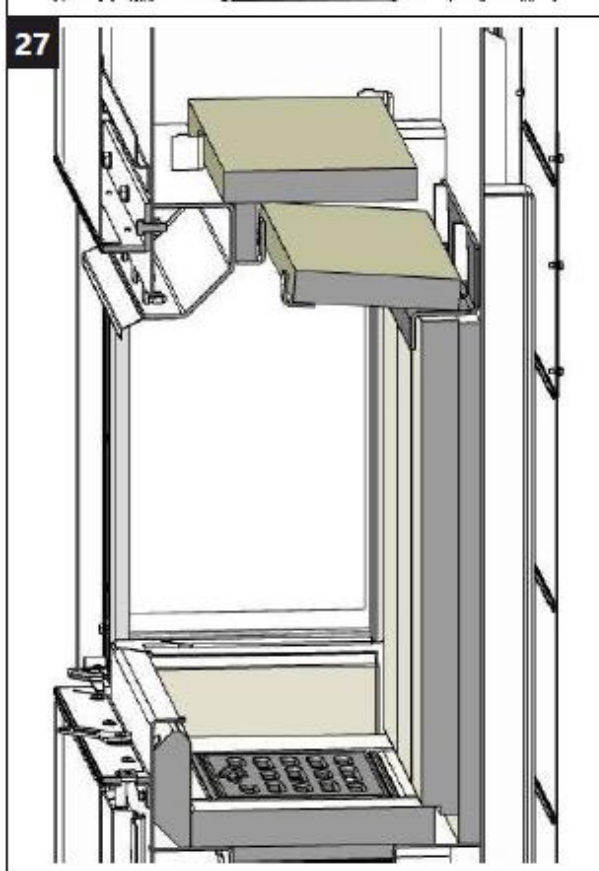
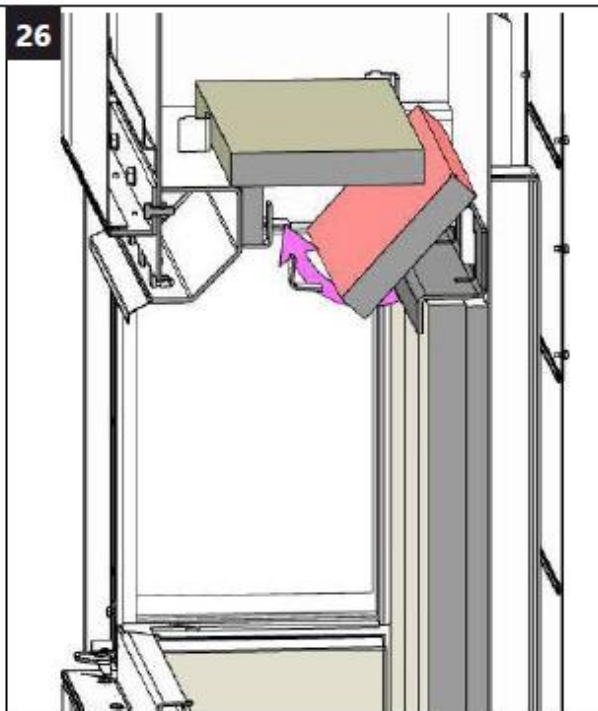
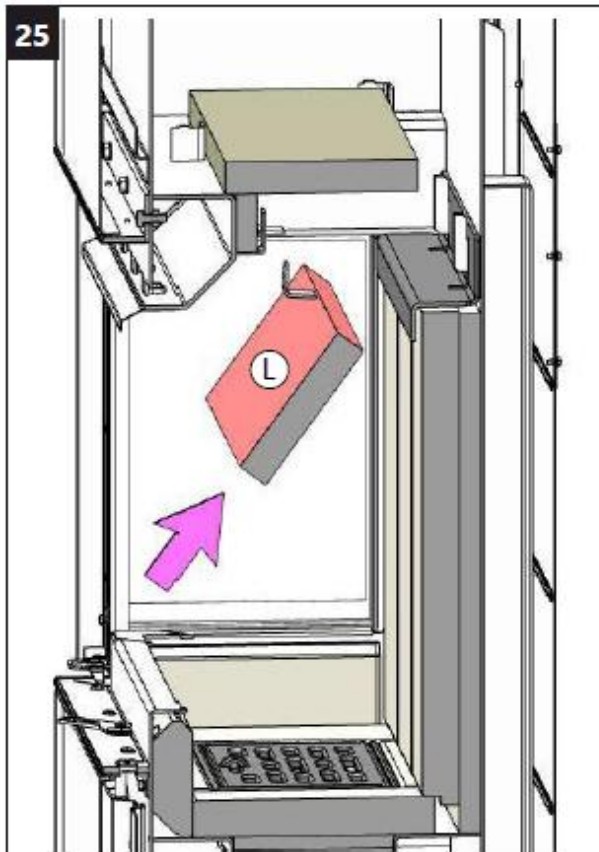

### Luchtinlaat van buitenaf - Prise d'air extérieur - External air intake

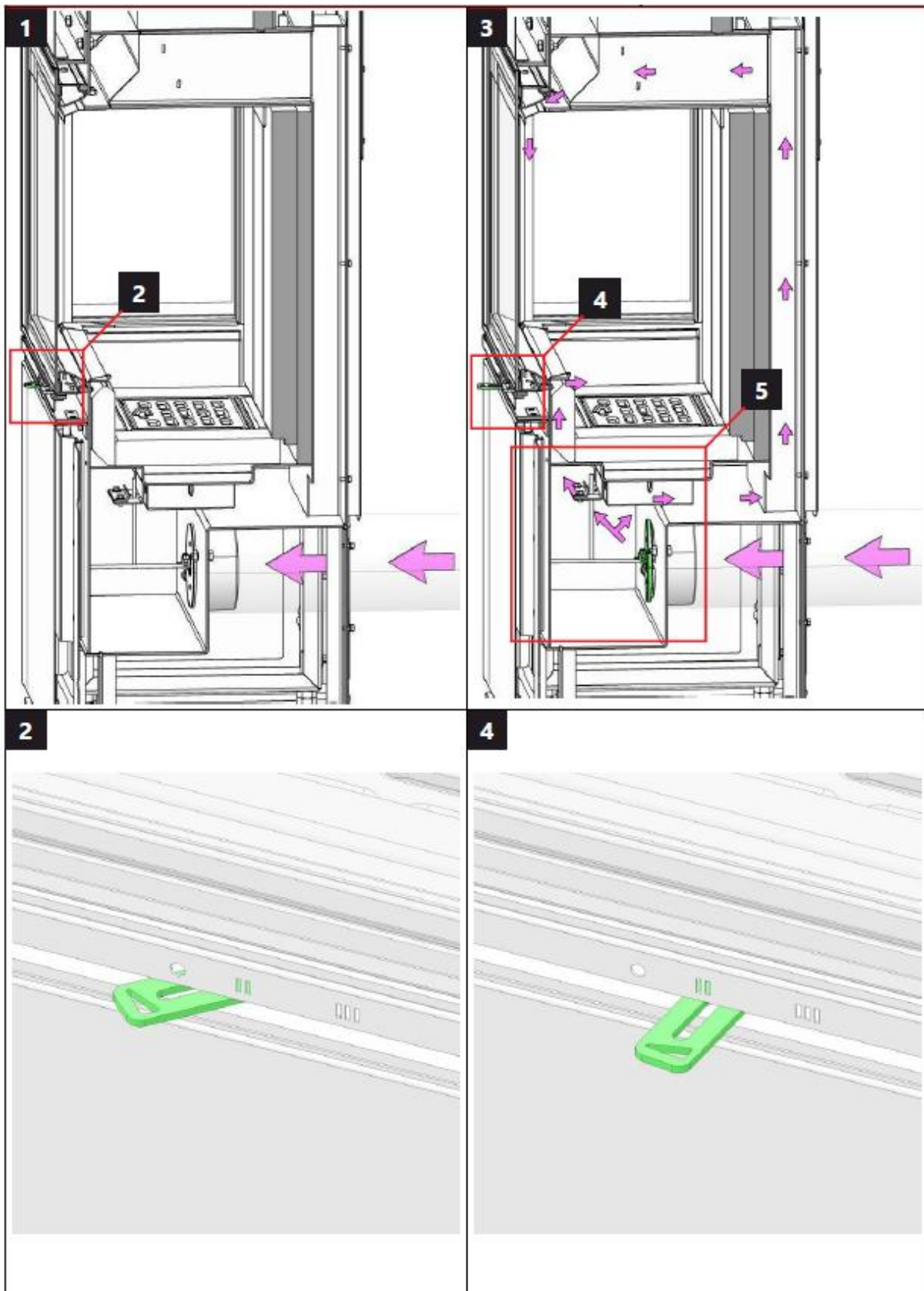

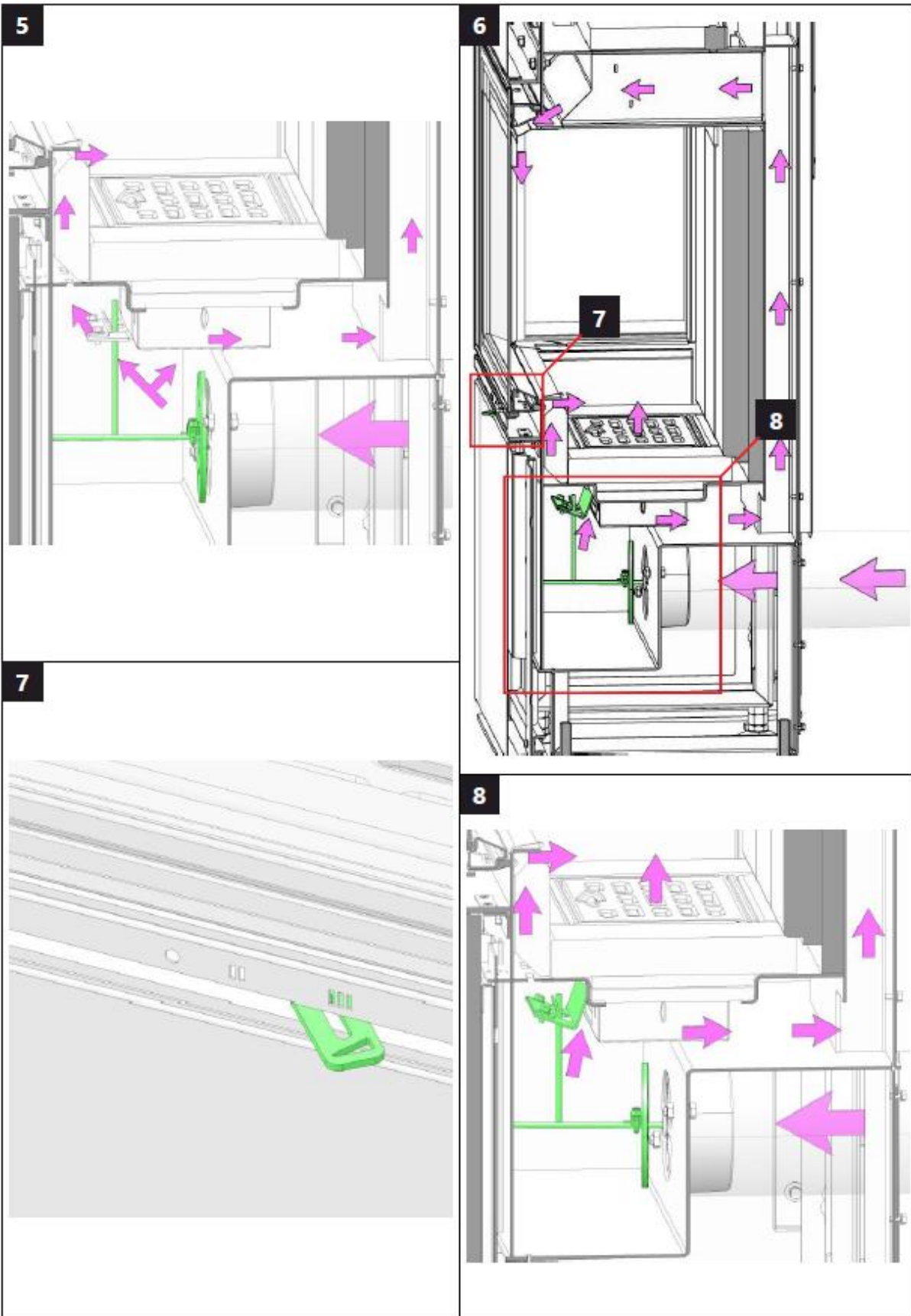

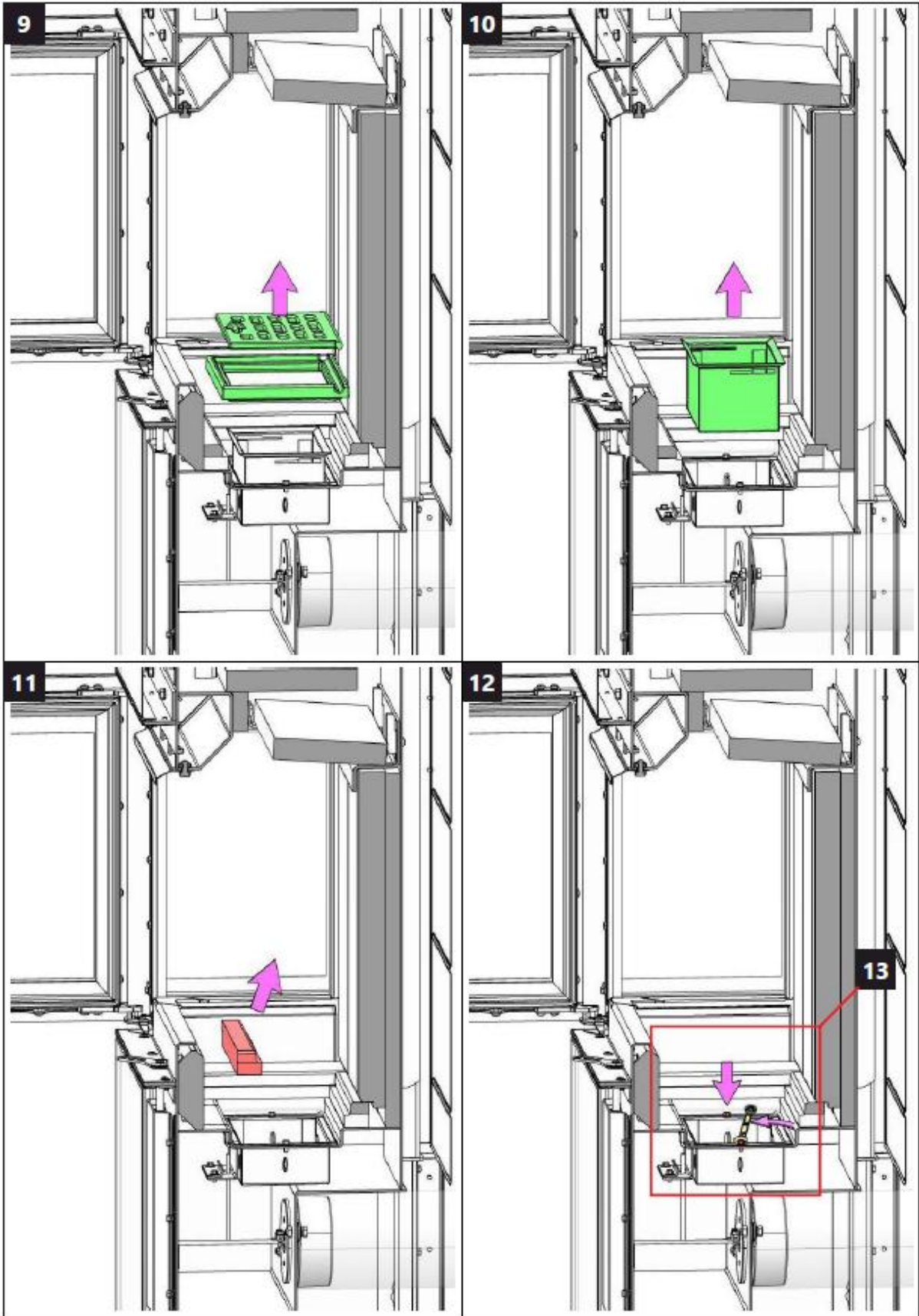

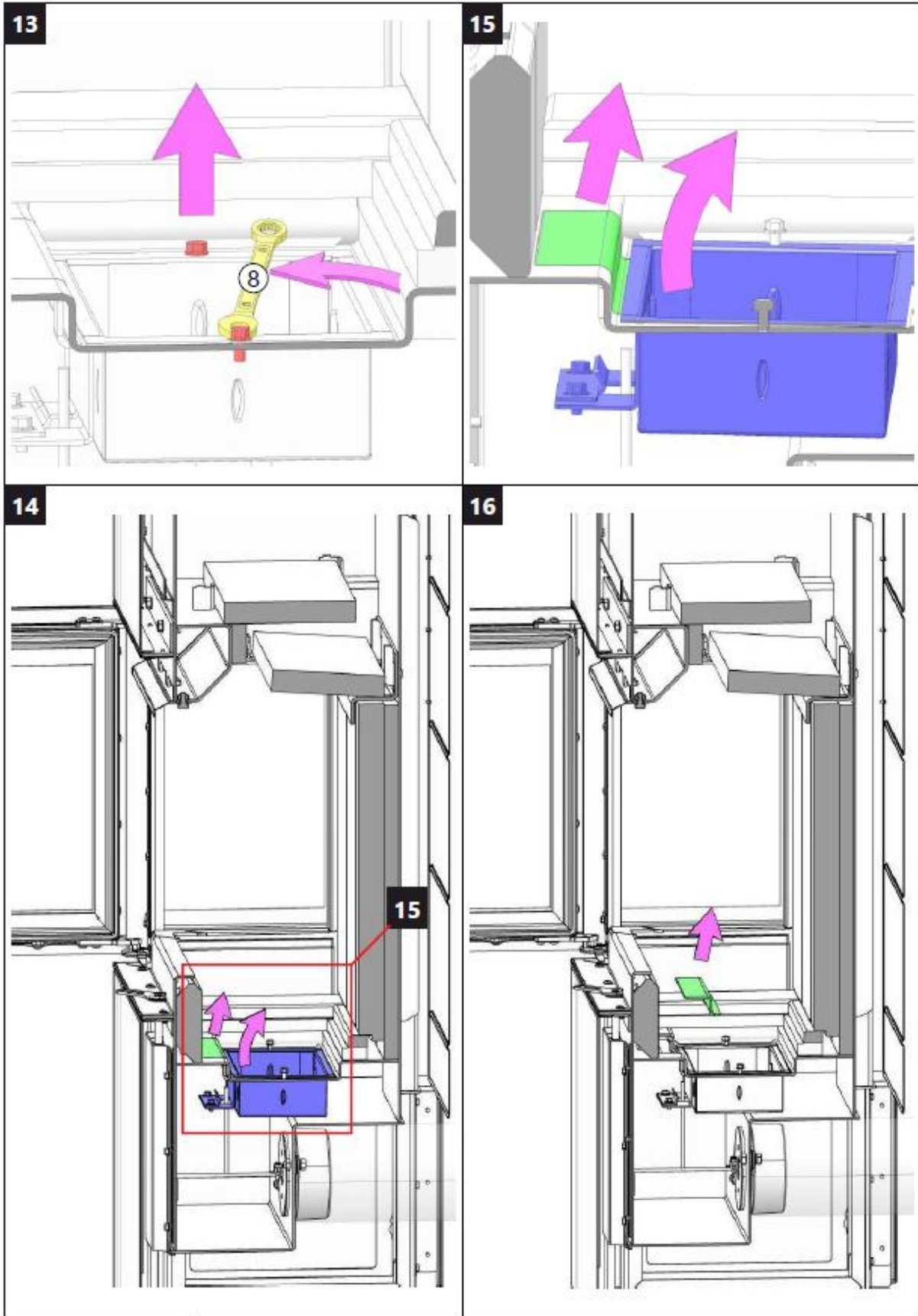

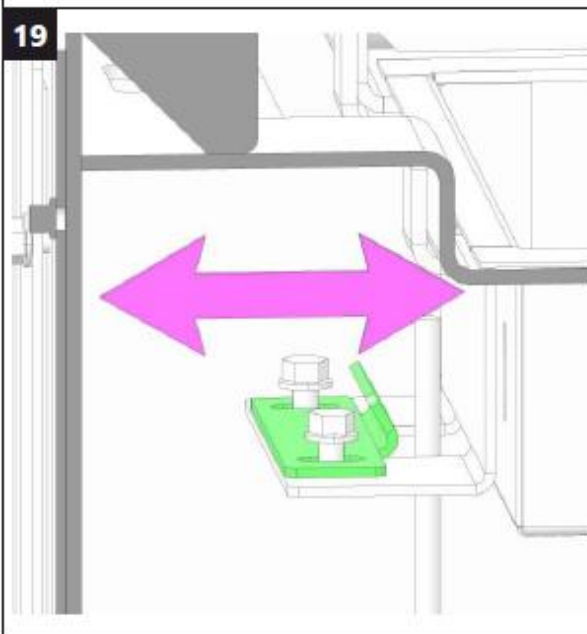
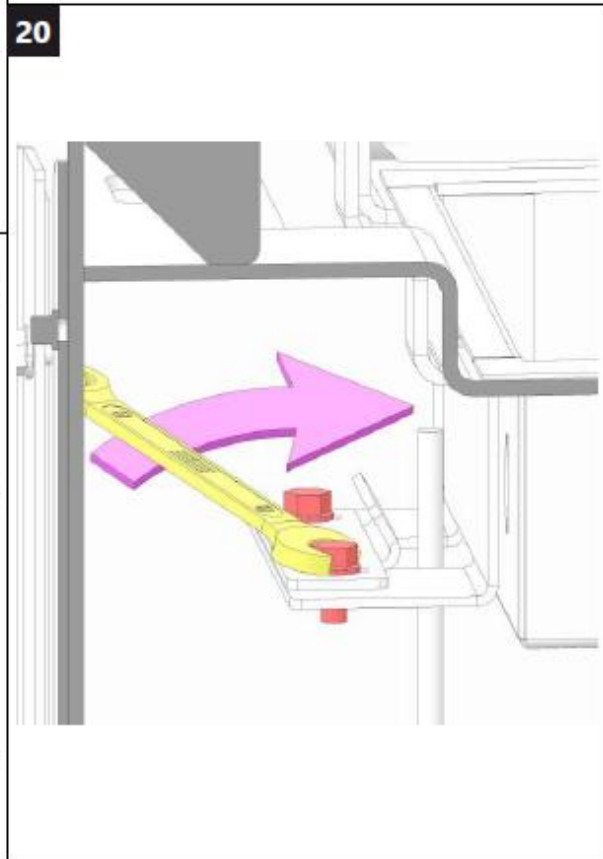
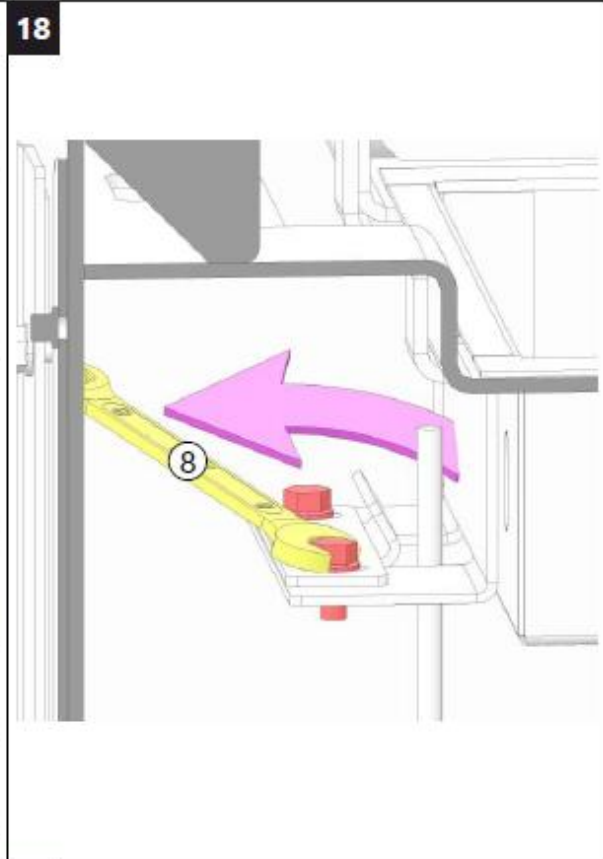
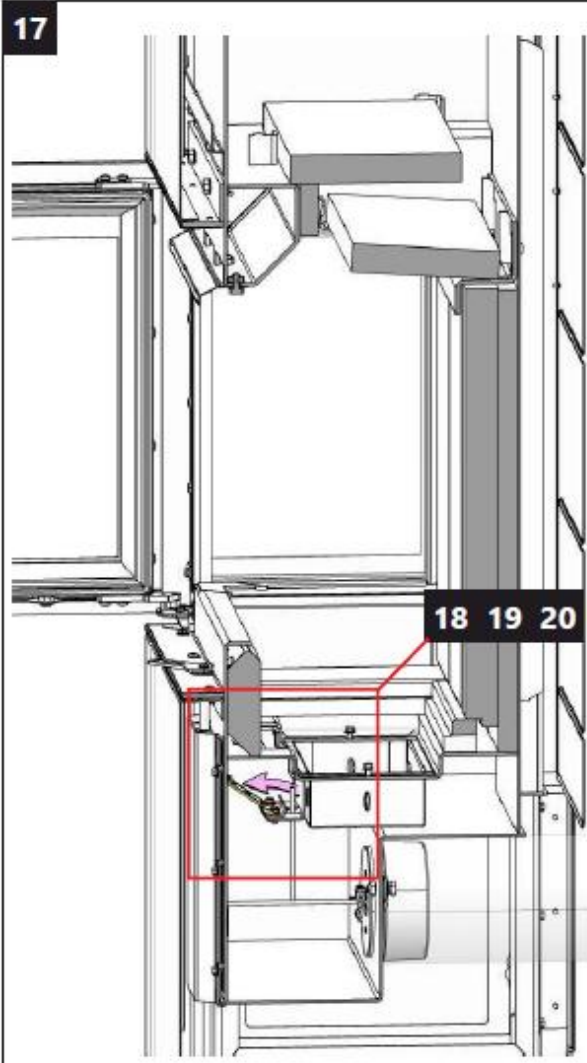

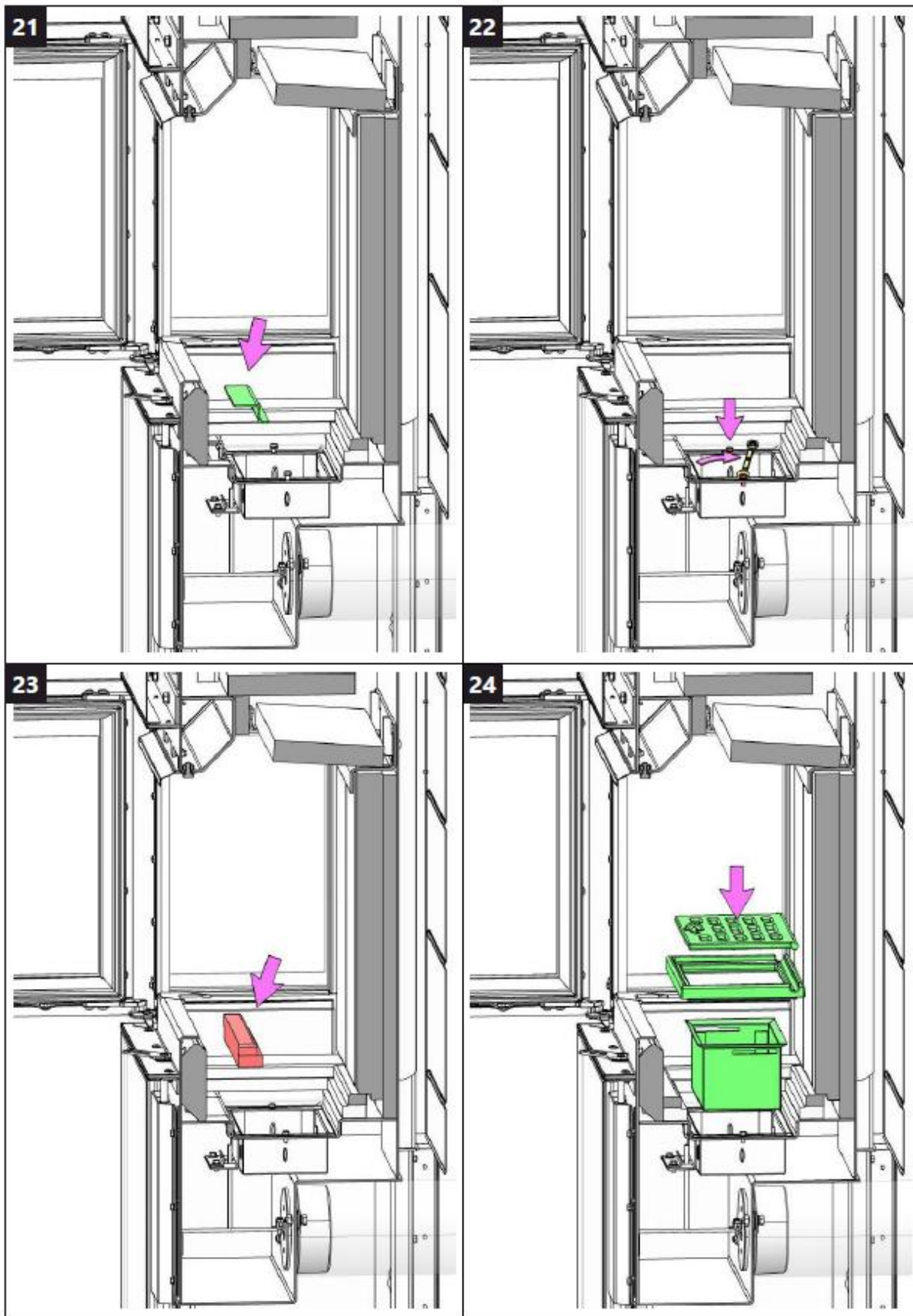

Reiniging van rookgaskanalen - Nettoyage des conduits de fumée - Cleaning of flue gas paths

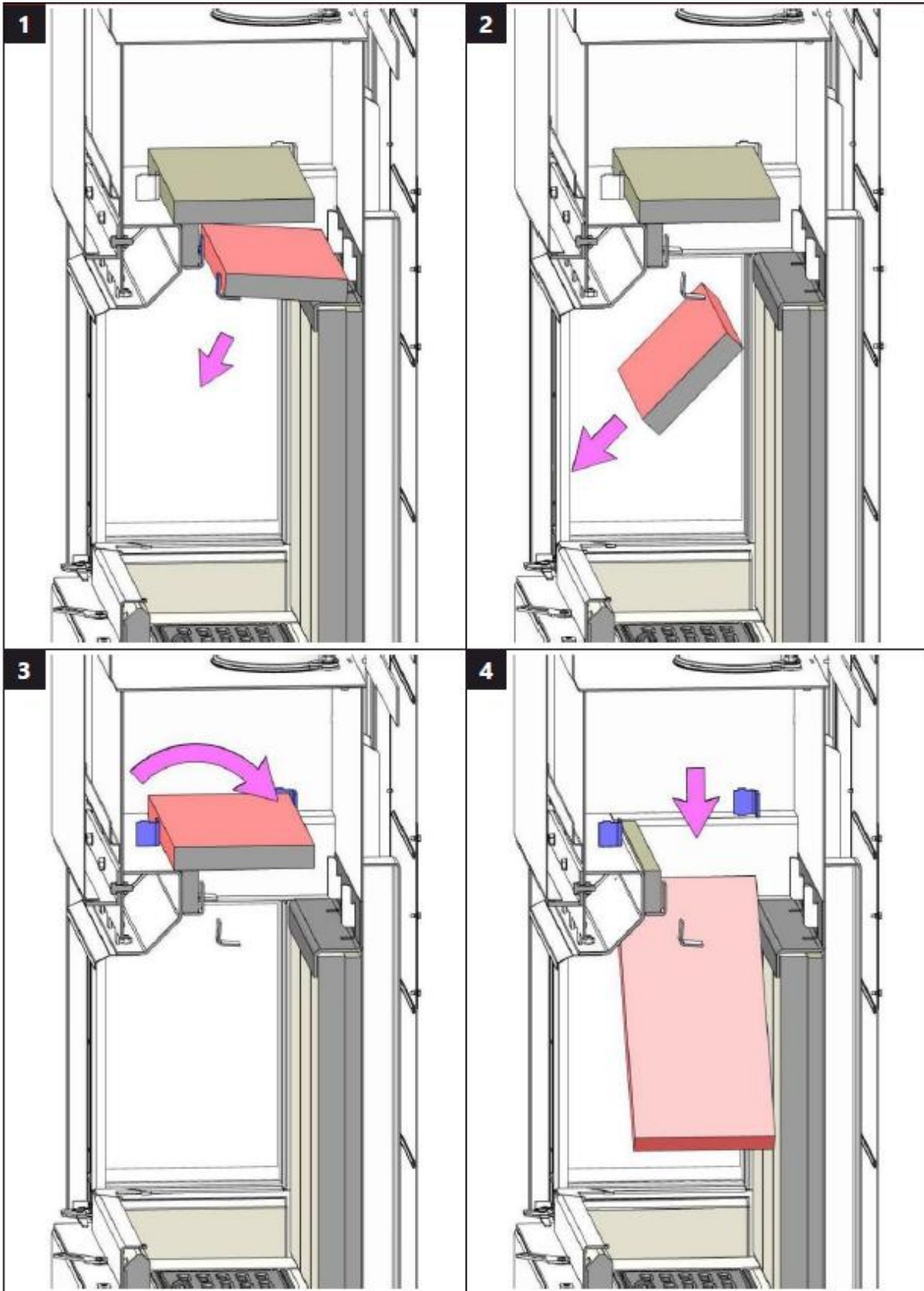

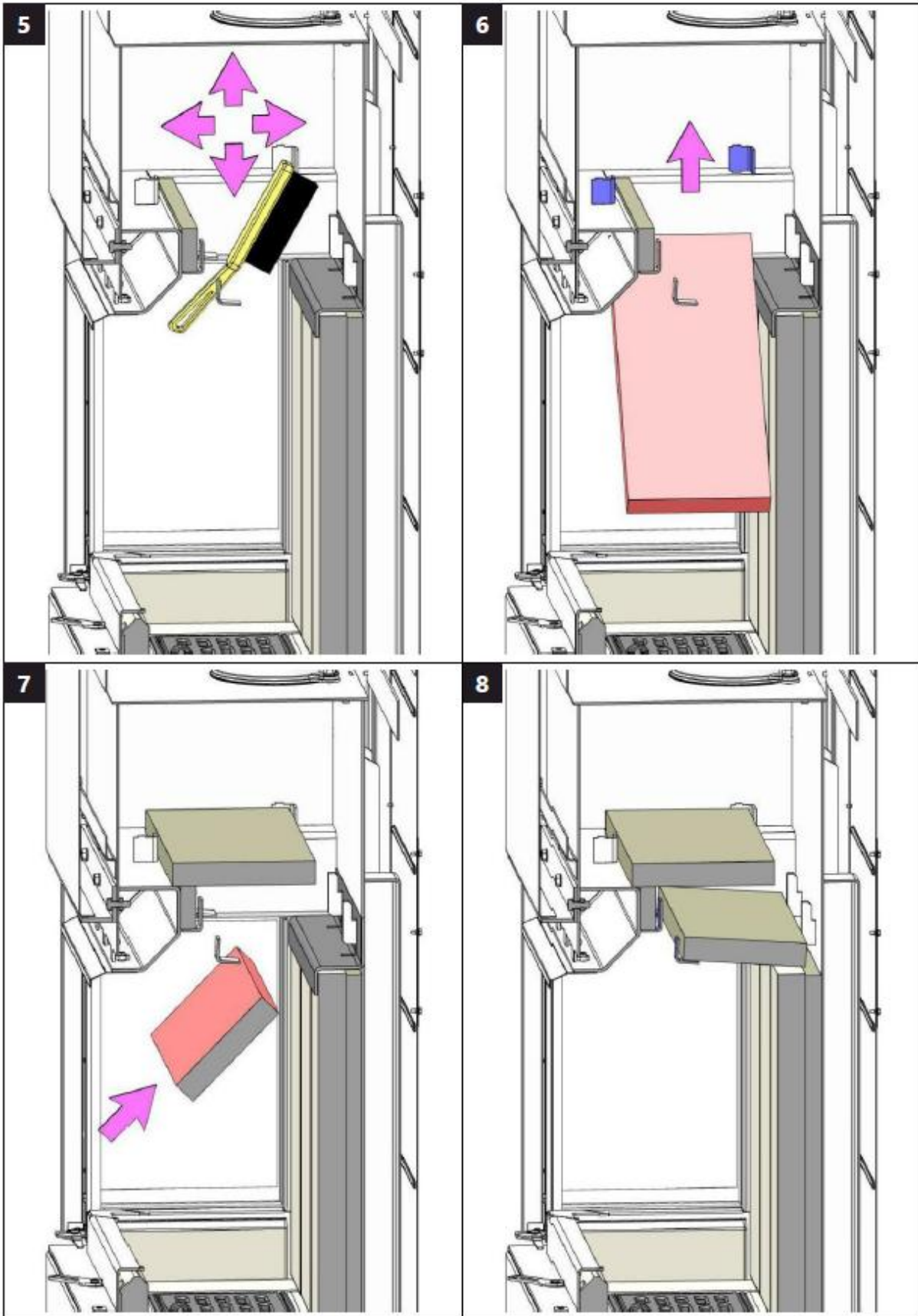

Haakje om de asbak te openen - Crochet pour ouvrir le cendrier - Hook to open ashtray

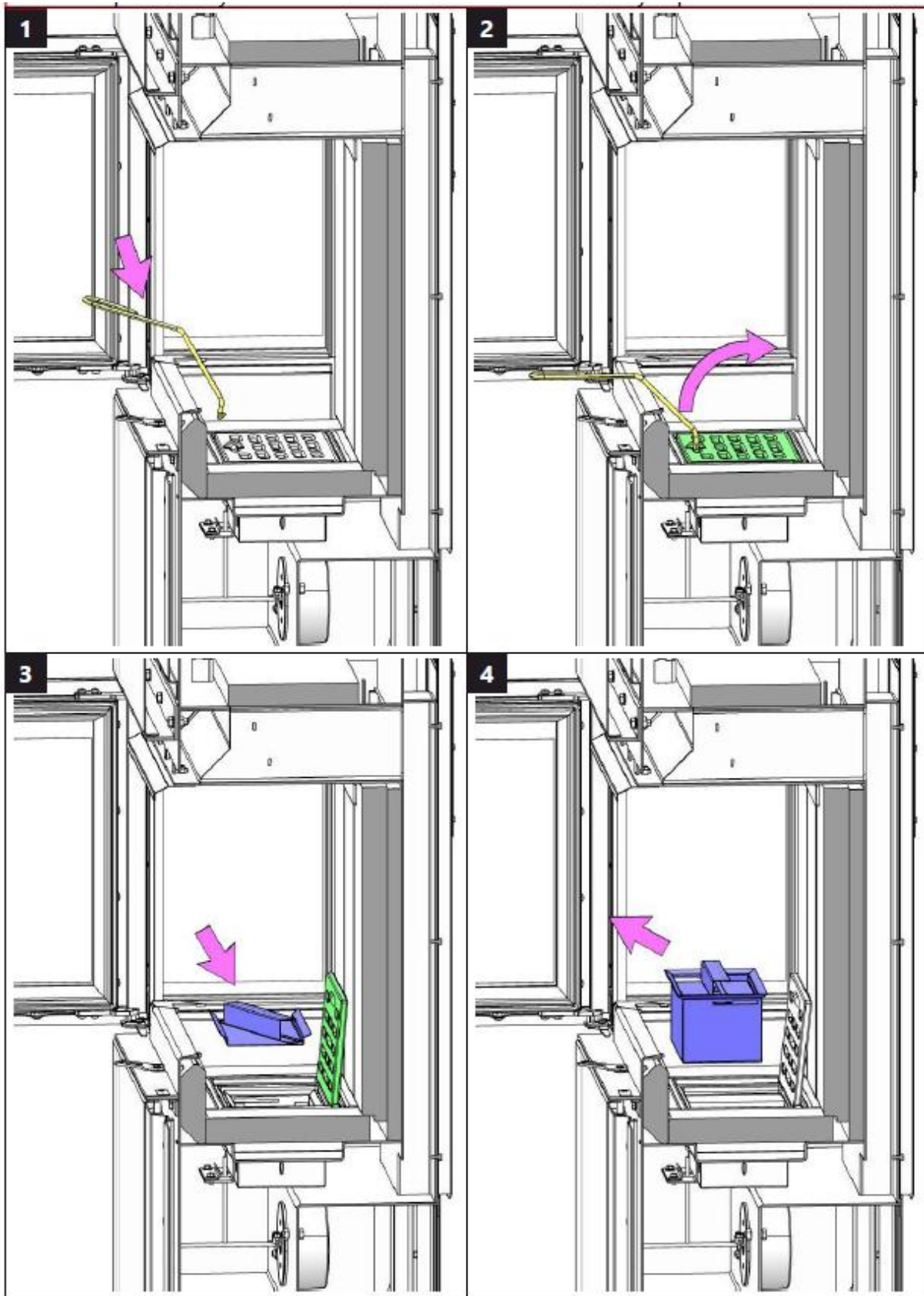

Gelieve bij problemen in onderhoud of werking uw installateur te contacteren  
Veuillez contacter votre installateur en cas de problèmes d'entretien ou de fonctionnement  
Please contact your installer in case of maintenance or operation problems



Industriepark De Bruwaan 17  
9700 Oudenaarde  
Belgium

**Versie 05 2026**